

Contents

	page
About this document	2
For your safety	3
Product description	5
Technical data	10
Mounting	25
Connecting to power supply and bus system	37
Set up the sensor with the display and adjustment module	44
Diagnosis, asset management and service	70
Dismount	81
Supplement	82



About this document

Function

This instruction provides all the information you need for mounting, connection and setup as well as important instructions for maintenance, fault rectification, safety and the exchange of parts. Please read this information before putting the instrument into operation and keep this manual accessible in the immediate vicinity of the device.

Target group

This instruction manual is directed to trained personnel. The contents of this manual must be made available to the qualified personnel and implemented.

Symbols used



Information, note, tip: This symbol indicates helpful additional information and tips for successful work.



Note: This symbol indicates notes to prevent failures, malfunctions, damage to devices or plants.



Caution: Non-observance of the information marked with this symbol may result in personal injury.



Warning: Non-observance of the information marked with this symbol may result in serious or fatal personal injury.



Danger: Non-observance of the information marked with this symbol results in serious or fatal personal injury.



Ex applications

This symbol indicates special instructions for Ex applications.



List

The dot set in front indicates a list with no implied sequence.



Sequence of actions

Numbers set in front indicate successive steps in a procedure.



Disposal

This symbol indicates special instructions for disposal.

For your safety

Authorised personnel

All operations described in this documentation must be carried out only by trained and authorized personnel.

During work on and with the device, the required personal protective equipment must always be worn.

Appropriate use

NivoGuide 8200 is a sensor for continuous level measurement.

You can find detailed information about the area of application in chapter "*Product description*".

Operational reliability is ensured only if the instrument is properly used according to the specifications in this document as well as possible supplementary instructions.

Warning about incorrect use

Inappropriate or incorrect use of this product can give rise to application-specific hazards, e.g. vessel overfill through incorrect mounting or adjustment. Damage to property and persons or environmental contamination can result. Also, the protective characteristics of the instrument can be impaired.

General safety instructions

This is a state-of-the-art instrument complying with all prevailing regulations and directives. The instrument must only be operated in a technically flawless and reliable condition. The operating company is responsible for the trouble-free operation of the instrument. When measuring aggressive or corrosive media that can cause a dangerous situation if the instrument malfunctions, the operating company has to implement suitable measures to make sure the instrument is functioning properly.

The safety instructions in this operating instructions manual, the national installation standards as well as the valid safety regulations and accident prevention rules must be observed.

For safety and warranty reasons, any invasive work on the device beyond that described in the operating instructions manual may be carried out only by personnel authorised by us. Arbitrary conversions or modifications are explicitly forbidden. For safety reasons, only the accessory specified by us must be used.

To avoid any danger, the safety approval markings and safety tips on the device must also be observed.

For your safety

Conformity

The device complies with the legal requirements of the applicable country-specific directives or technical regulations. We confirm conformity with the corresponding labelling.

The corresponding conformity declarations can be found on our homepage.

Electromagnetic compatibility

Instruments in four-wire or Ex d ia version are designed for use in an industrial environment. Nevertheless, electromagnetic interference from electrical conductors and radiated emissions must be taken into account, as is usual with class A instruments according to EN 61326-1. If the instrument is used in a different environment, the electromagnetic compatibility to other instruments must be ensured by suitable measures.

NAMUR recommendations

NAMUR is the automation technology user association in the process industry in Germany. The published NAMUR recommendations are accepted as the standard in field instrumentation.

The device fulfils the requirements of the following NAMUR recommendations:

- NE 21 – Electromagnetic compatibility of equipment
- NE 53 – Compatibility of field devices and display/adjustment components
- NE 107 – Self-monitoring and diagnosis of field devices

For further information see www.namur.de.

Installation and operation in the USA and Canada

This information is only valid for USA and Canada. Hence the following text is only available in the English language.

Installations in the US shall comply with the relevant requirements of the National Electrical Code (NEC - NFPA 70) (USA).

Installations in Canada shall comply with the relevant requirements of the Canadian Electrical Code (CEC Part I) (Canada).

Safety instructions for Ex areas

For applications in hazardous areas (Ex), only devices with corresponding Ex approval may be used. Observe the Ex-specific safety instructions. These are an integral part of the device documentation and are enclosed with every device with Ex approval.

Product description

Scope of delivery

Configuration

The scope of delivery encompasses:

- Sensor NivoGuide 8200
- Optional accessory

The further scope of delivery encompasses:

- Documentation
 - Quick setup guide NivoGuide 8200
 - Instructions for optional instrument features
 - Ex-specific "*Safety instructions*" (with Ex versions)
 - If necessary, further certificates



Information:

Optional instrument features are also described in this operating instructions manual. The respective scope of delivery results from the order specification.

Type label

The type label contains the most important data for identification and use of the instrument:

- Instrument type
- Information about approvals
- Configuration information
- Technical data
- Serial number of the instrument
- QR code for device identification
- Numerical code for Bluetooth access (optional)
- Manufacturer information

Documents and software

Further information can be found on our homepage.

There you will find the documentation and further information about the device.

Principle of operation

Application area

The NivoGuide 8200 is a level sensor with cable or rod probe for continuous level or interface measurement, especially for applications in high temperatures up to +250° C (482° F).

Functional principle - level measurement

High frequency microwave pulses are guided along a steel cable or a rod. Upon reaching the medium surface, the microwave pulses are reflected. The running time is evaluated by the instrument and output as level.

Product description

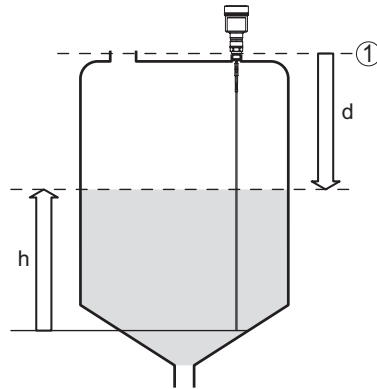

Fig. 1: Level measurement

- 1 Sensor reference plane (seal surface of the process fitting)
- d Distance to the level
- h Height - Level

Functional principle - interface measurement

High frequency microwave impulses are guided along a steel cable or rod. Upon reaching the medium surface, a part of the microwave impulses is reflected. The other part passes through the upper product and is reflected by the interface. The running times to the two product layers are processed by the instrument.

Product description

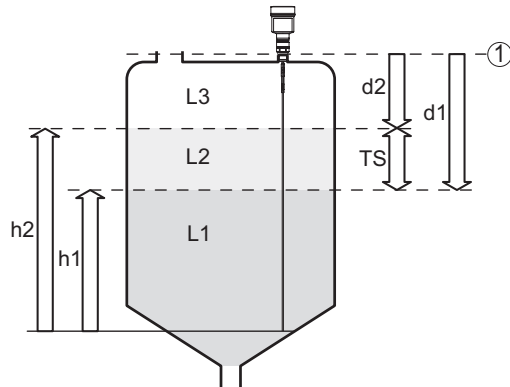

Fig. 2: Interface measurement

- 1 Sensor reference plane (seal surface of the process fitting)
- d1 Distance to the interface
- d2 Distance to the level
- TS Thickness of the upper medium ($d1 - d2$)
- h1 Height - Interface
- h2 Height - Level
- L1 Lower medium
- L2 Upper medium
- L3 Gas phase

Prerequisites for interface measurement

Upper medium (L2)

- The upper medium must not be conductive
- The dielectric constant of the upper medium or the actual distance to the interface must be known (input required).
Min. dielectric constant: 1.6.
- The composition of the upper medium must be stable, no varying products or mixtures
- The upper medium must be homogeneous, no stratifications within the medium
- Min. thickness of the upper medium 50 mm (1.97 in)
- Clear separation from the lower medium, emulsion phase or detritus layer max. 50 mm (1.97 in)
- If possible, no foam on the surface

Lower medium (L1)

- The dielectric constant must be 10 higher than the dielectric constant of the upper medium, preferably electrically conductive. Example: upper medium dielectric constant 2, lower medium at least dielectric constant 12.

Gas phase (L3)

- Air or gas mixture

Product description

- Gas phase - dependent on the application, gas phase does not always exist ($d_2 = 0$)

Output signal

The instrument is always preset to the application "*Level measurement*".

For the interface measurement, you can select the requested output signal with the setup.

Packaging, transport and storage

Packaging

Your instrument was protected by packaging during transport. Its capacity to handle normal loads during transport is assured by a test based on ISO 4180.

The packaging consists of environment-friendly, recyclable cardboard. For special versions, PE foam or PE foil is also used. Dispose of the packaging material via specialised recycling companies.

Transport

Transport must be carried out in due consideration of the notes on the transport packaging. Nonobservance of these instructions can cause damage to the device.

Transport inspection

The delivery must be checked for completeness and possible transit damage immediately at receipt. Ascertained transit damage or concealed defects must be appropriately dealt with.

Storage

Up to the time of installation, the packages must be left closed and stored according to the orientation and storage markings on the outside.

Unless otherwise indicated, the packages must be stored only under the following conditions:

- Not in the open
- Dry and dust free
- Not exposed to corrosive media
- Protected against solar radiation
- Avoiding mechanical shock and vibration

Storage and transport temperature

- Storage and transport temperature see chapter "*Supplement - Technical data - Ambient conditions*"
- Relative moisture 20 ... 85 %

Lifting and carrying

With instrument weights of more than 18 kg (39.68 lbs) suitable and approved equipment must be used for lifting and carrying.

Product description

Accessories

The instructions for the listed accessories can be found in the download area on our homepage.

Display and adjustment module

The display and adjustment module is used for measured value indication, adjustment and diagnosis.

Flanges

Screwed flanges are available in different versions according to the following standards: DIN 2501, EN 1092-1, BS 10, ASME B 16.5, JIS B 2210-1984, GOST 12821-80.

Technical data

Technical data

Note for approved instruments

The technical data in the respective safety instructions which are included in delivery are valid for approved instruments (e.g. with Ex approval). These data can differ from the data listed herein, for example regarding the process conditions or the voltage supply.

All approval documents can be downloaded from our homepage.

General data

Material 316L corresponds to 1.4404 or 1.4435

Materials, wetted parts

- Process fitting - rod version 316L and PEEK GF30
 Alloy C22 (2.4602) and PEEK GF30, 904L (1.4539)
- Process fitting - cable version 316L and PEEK GF30
- Rod: \varnothing 8 mm (0.315 in) 316L or Alloy C22 (2.4602)
- Cable: \varnothing 2 mm (0.079 in) 316 (1.4401), Duplex steel (1.4462)
- Cable: \varnothing 4 mm (0.157 in) 316 (1.4401)
- Gravity weight (optionally available) 316L
- Process seal on the instrument side (rod leadthrough) FFKM (Kalrez 6375)¹⁾
 FFKM (Perlast G74S)
- Process seal On site (instruments with thread: Klingersil C-4400 is enclosed)

Materials, non-wetted parts

- Aluminium die-cast housing Aluminium die-casting AlSi10Mg, powder-coated (Basis: Polyester)
- Stainless steel housing (electropolished) 316L
- Second Line of Defense Borosilicate glass GPC 540
- Seal between housing and housing lid Silicone SI 850 R
- Inspection window in housing cover (optional) Polycarbonate
- Ground terminal 316L
- Cable gland PA, stainless steel, brass
- Sealing, cable gland NBR

¹⁾ Not suitable for hot steam applications > 150 °C (> 302 °F). In this case, use a device with a ceramic-graphite seal.

Technical data

- Blind plug, cable gland	PA
Second Line of Defense	
- The Second Line of Defense (SLOD) is a second level of the process separation in the form of a gas-tight feedthrough in the lower part of the housing, preventing product from penetrating into the housing.	
- Supporting material	316L
- Glass potting	Borosilicate glass GPC 540
- Contacts	Alloy C22 (2.4602)
- Helium leak rate	< 10 ⁻⁶ mbar l/s
- Pressure resistance	See process pressure of the sensor
Process fittings	
- Pipe thread, cylindrical (ISO 228 T1)	G ³ / ₄ , G1, G1½ (DIN 3852-A)
- Pipe thread, conical (ASME B1.20.1)	¾ NPT, 1 NPT, 1½ NPT
- Flanges	DIN from DN 25, ASME from 1"
Weight	
- Instrument weight (depending on process fitting)	approx. 0.8 ... 8 kg (0.176 ... 17.64 lbs)
- Rod: ø 8 mm (0.315 in)	approx. 400 g/m (4.31 oz/ft)
- Cable: ø 2 mm (0.079 in)	approx. 20 g/m (0.22 oz/ft)
- Cable: ø 4 mm (0.157 in)	approx. 80 g/m (0.86 oz/ft)
- Gravity weight	approx. 325 g (11.5 oz)
Probe length L (from seal surface)	
- Rod: ø 8 mm (0.315 in)	up to 4 m (13.12 ft)
- Trimming accuracy (rod)	±(2 mm + 0.05 % of the rod length)
- Cable: ø 2 mm (0.079 in)	up to 32 m (105 ft)
- Cable: ø 4 mm (0.157 in)	up to 32 m (105 ft)
- Trimming accuracy (cable)	±(2 mm + 0.05 % of the cable length)
Lateral load	
- Rod: ø 8 mm (0.315 in)	4 Nm (3 lbf ft)
Max. tensile load with cable: ø 2 mm 1.5 KN (337 lbf) (0.079 in)	

Technical data

Max. tensile load with cable: ø 4 mm (0.157 in)	2.5 KN (562 lbf)
Thread in gravity weight (cable version)	M 12

Input variable

Measured variable	Level of liquids
Min. dielectric constant of the medium - rod, cable version	> 1.7

Output variable

Output

- Physical layer	Digital output signal according to standard EIA-485
- Bus specifications	Modbus Application Protocol V1.1b3, Modbus over serial line V1.02
- Data protocols	Modbus RTU, Modbus ASCII, Levelmaster
Max. transmission rate	57.6 Kbit/s

Measurement accuracy (according to DIN EN 60770-1)

Process reference conditions according to DIN EN 61298-1

- Temperature	+18 ... +30 °C (+64 ... +86 °F)
- Relative humidity	45 ... 75 %
- Air pressure	+860 ... +1060 mbar/+86 ... +106 kPa (+12.5 ... +15.4 psig)

Mounting, reference conditions

- Min. distance to internal installations	> 500 mm (19.69 in)
- Vessel	metallic, ø 1 m (3.281 ft), centric mounting, process fitting flush with the vessel ceiling
- Medium	Water/Oil (dielectric constant ~2.0) ¹⁾
- Mounting	Probe end does not touch the vessel bottom
Sensor parameter adjustment	No gating out of false signals carried out

¹⁾ With interface measurement = 2.0.

Technical data

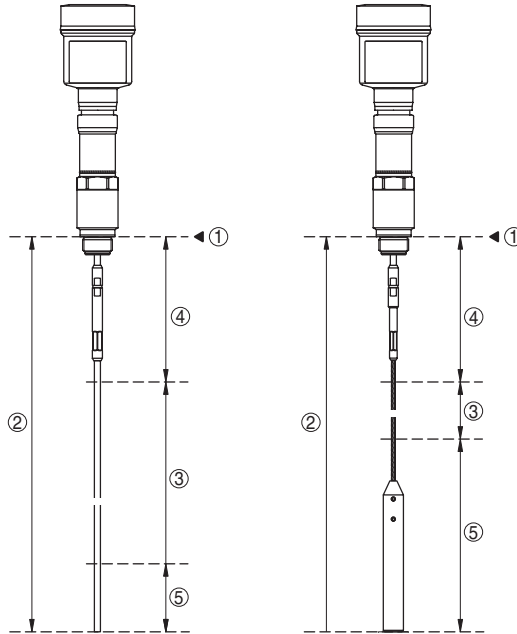

Fig. 3: Measuring ranges - NivoGuide 8200

- 1 Reference plane
- 2 Probe length
- 3 Measuring range (default setting refers to the measuring range in water)
- 4 Upper blocking distance (see following diagrams - grey section)
- 5 Lower blocking distance (see following diagrams - grey section)

Typical deviation - Interface measurement $\pm 5 \text{ mm (0.197 in)}$

Typical deviation - Total level interface measurement See following diagrams

Typical deviation - Level measurement¹⁾²⁾ See following diagrams

¹⁾ Depending on the mounting conditions, deviations can occur which can be rectified by adapting the adjustment or changing the measured value offset in the DTM service mode

²⁾ The blocking distances can be optimized via a false signal suppression.

Technical data

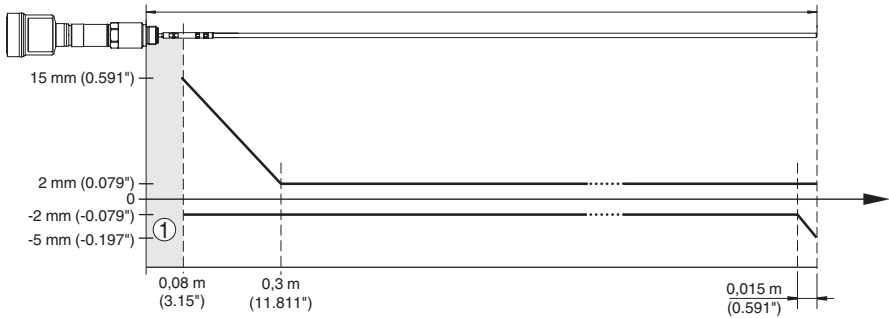

Fig. 4: Deviation NivoGuide 8200 in rod version in water

- 1 Blocking distance (no measurement possible in this area)
- L Probe length

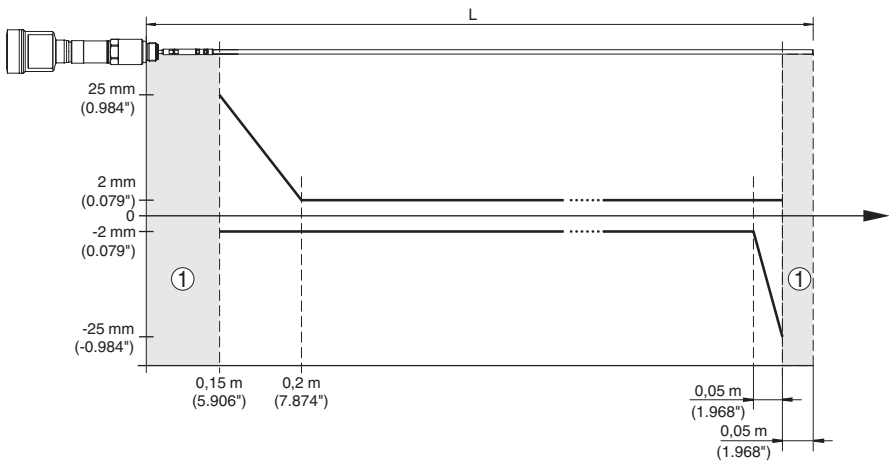

Fig. 5: Deviation NivoGuide 8200 in rod version in oil

- 1 Blocking distance (no measurement possible in this area)
- L Probe length

Technical data

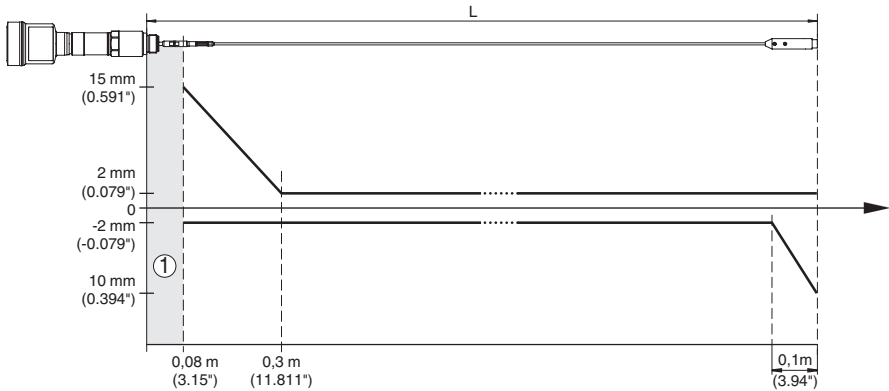

Fig. 6: Deviation NivoGuide 8200 in cable version in water

- 1 Blocking distance (no measurement possible in this area)
 When using a centering weight, it is only possible to measure up to the upper edge of the centering weight.
- L Probe length

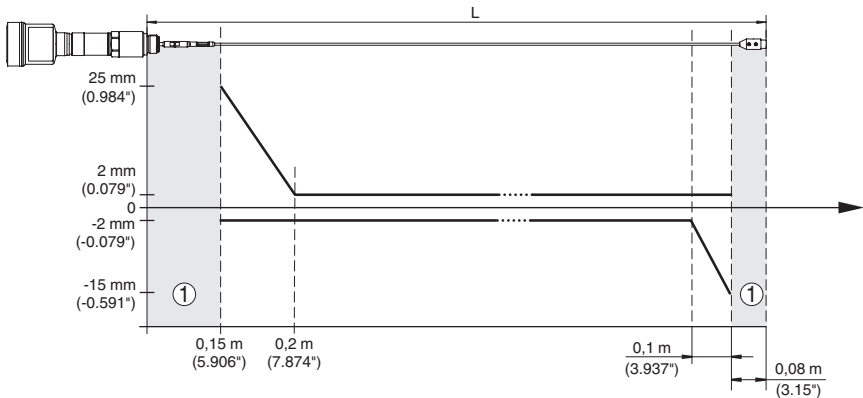

Fig. 7: Deviation NivoGuide 8200 in cable version (\varnothing 2 mm/0.079 in), in medium oil

- 1 Blocking distance (no measurement possible in this area)
 When using a centering weight, it is only possible to measure up to the upper edge of the centering weight.
- L Probe length

Technical data

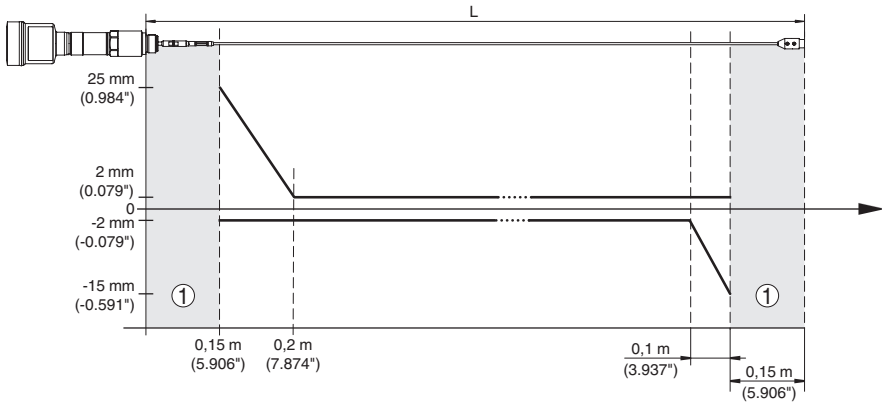

Fig. 8: Deviation NivoGuide 8200 in cable version (\varnothing 4 mm/0.157 in), in medium oil

- 1 Blocking distance (no measurement possible in this area)
 When using a centering weight, it is only possible to measure up to the upper edge of the centering length.
- L Probe length

Non-repeatability $\leq \pm 1$ mm

Variables influencing measurement accuracy

Temperature drift - Digital output ± 3 mm/10 K relating to the max. measuring range or max. 10 mm (0.394 in)

Additional deviation through electromagnetic interference acc. to EN 61326 $< \pm 10$ mm ($< \pm 0.394$ in)

Influence of the superimposed gas and pressure on measurement accuracy

The propagation speed of the radar impulses in gas or vapour above the medium is reduced by high pressure. This effect depends on the superimposed gas or vapours.

The following table shows the resulting deviation for some typical gases and vapours. The specified values refer to the distance. Positive values mean that the measured distance is too large, negative values that the measured distance is too small.

Gas phase	Temperature	Pressure		
		1 bar (14.5 psig)	10 bar (145 psig)	50 bar (725 psig)
Air	20 °C (68 °F)	0 %	0.22 %	1.2 %
	200 °C (392 °F)	-0.01 %	0.13 %	0.74 %
	400 °C (752 °F)	-0.02 %	0.08 %	0.52 %

Technical data

Gas phase	Temperature	Pressure		
		1 bar (14.5 psig)	10 bar (145 psig)	50 bar (725 psig)
Hydrogen	20 °C (68 °F)	-0.01 %	0.1 %	0.61 %
	200 °C (392 °F)	-0.02 %	0.05 %	0.37 %
	400 °C (752 °F)	-0.02 %	0.03 %	0.25 %
Steam (saturated steam)	100 °C (212 °F)	0.26 %	-	-
	150 °C (302 °F)	0.17 %	2.1 %	-

Characteristics and performance data

Measuring cycle time	< 500 ms
Step response time ¹⁾	≤ 3 s
Max. filling/emptying speed	1 m/min Products with high dielectric constant (> 10) up to 5 m/minute

Ambient conditions

Ambient, storage and transport temperature

- Standard -40 ... +80 °C (-40 ... +176 °F)
- CSA, Ordinary Location -40 ... +60 °C (-40 ... +140 °F)

Process conditions

For the process conditions, please also note the specifications on the type label. The lowest value always applies.

The measurement error through the process conditions in the specified pressure and temperature range is < 1 %.

Vessel pressure relating to the flange nominal pressure stage	see supplementary instructions manual " <i>Flanges according to DIN-EN-ASME-JIS</i> "
Process pressure	-1 ... +100 bar/-100 ... +10000 kPa (-14.5 ... +1450 psig), depending on the process fitting
Process temperature (thread or flange temperature)	-20 ... +250 °C (-4 ... +482 °F)

¹⁾ Time span after a sudden measuring distance change by max. 0.5 m in liquid applications, max 2 m with bulk solids applications, until the output signal has taken for the first time 90 % of the final value (IEC 61298-2).

Technical data

The measurement error from the process conditions is in the specified pressure and temperature range of below 1 %.

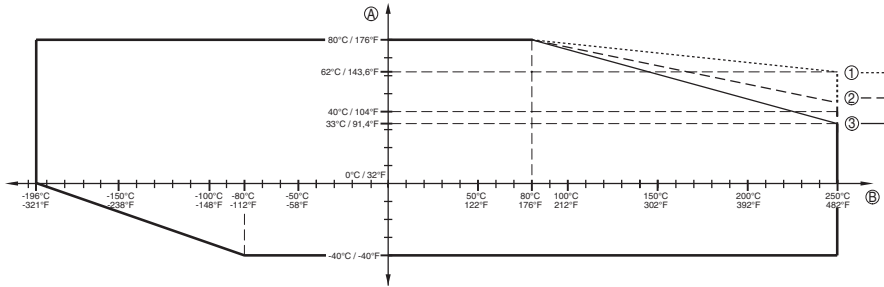

Fig. 9: Ambient temperature - process temperature, standard version

- A Ambient temperature
- B Process temperature (depending on the seal material)
- 1 Aluminium housing
- 2 Stainless steel housing (precision casting)
- 3 Stainless steel housing (electropolished)

Flanges of 904L (1.4539): see ASME B16.5-2013, Table 2-3.11, permissible temperature range: -60 ... +400 °C (-76 ... 752 °F)

Vibration resistance

- Rod probe: 1 g with 5 ... 200 Hz according EN 60068-2-6 (vibration at resonance) with rod length 50 cm (19.69 in)

Shock resistance

- Rod probe: 25 g, 6 ms according to EN 60068-2-27 (mechanical shock) with rod length 50 cm (19.69 in)

Electromechanical data - version IP67

Options of the cable entry

- Cable entry: M20 x 1.5; ½ NPT
- Cable gland: M20 x 1.5; ½ NPT (cable ø see below table)
- Blind plug: M20 x 1.5; ½ NPT
- Closing cap: ½ NPT

Material cable gland	Material seal insert	Cable diameter				
		4.5 ... 8.5 mm	5 ... 9 mm	6 ... 12 mm	7 ... 12 mm	10 ... 14 mm
PA	NBR	-	✓	✓	-	✓

Technical data

Material cable gland	Material seal insert	Cable diameter				
		4.5 ... 8.5 mm	5 ... 9 mm	6 ... 12 mm	7 ... 12 mm	10 ... 14 mm
Brass, nickel-plated	NBR	√	√	√	-	-
Stainless steel	NBR	-	√	√	-	√

Wire cross-section (spring-loaded terminals)

- Massive wire, stranded wire 0.2 ... 2.5 mm² (AWG 24 ... 14)
- Stranded wire with end sleeve 0.2 ... 1.5 mm² (AWG 24 ... 16)

Integrated clock

Date format	Day.Month.Year
Time format	12 h/24 h
Time zone, factory setting	CET
Max. rate deviation	10.5 min/year

Additional output parameter - Electronics temperature

Range	-40 ... +85 °C (-40 ... +185 °F)
Resolution	< 0.1 K
Deviation	± 3 K
Availability of the temperature values	
- Indication	Via the display and adjustment module
- Output	Via the respective output signal

Voltage supply

Operating voltage	8 ... 30 V DC
Max. power consumption	520 mW
Reverse voltage protection	Integrated

Electrical protective measures

Housing material	Version	Protection acc. to IEC 60529	Protection acc. to NEMA
Aluminium	Single chamber	IP66/IP68 (0.2 bar)	Type 6P
Stainless steel (electro-polished)	Single chamber	IP66/IP68 (0.2 bar)	Type 6P

Technical data

Connection of the feeding power supply unit	Networks of overvoltage category III
Altitude above sea level	
- by default	up to 2000 m (6562 ft)
- with connected overvoltage protection	up to 5000 m (16404 ft)
Pollution degree (with fulfilled housing protection)	4
Protection rating (IEC 61010-1)	III

Dimensions

The following dimensional drawings are only an extract of the possible versions.

Aluminium housing

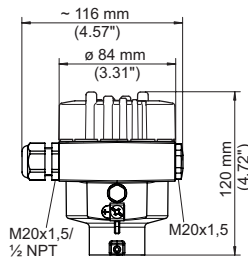

Fig. 10: Housing versions with protection rating IP66/IP68 (0.2 bar), (with integrated display and adjustment module the housing is 9 mm/0.35 in higher)

Aluminium - single chamber

Technical data

Stainless steel housing

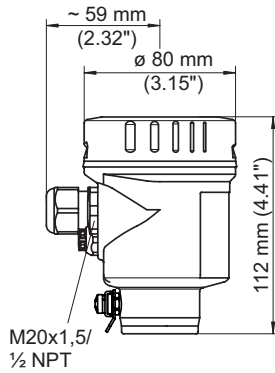

Fig. 11: Housing versions with protection rating IP66/IP68 (0.2 bar), (with integrated display and adjustment module the housing is 9 mm/0.35 in higher)

Stainless steel single chamber (electropolished)

Technical data

NivoGuide 8200, cable version with gravity weight

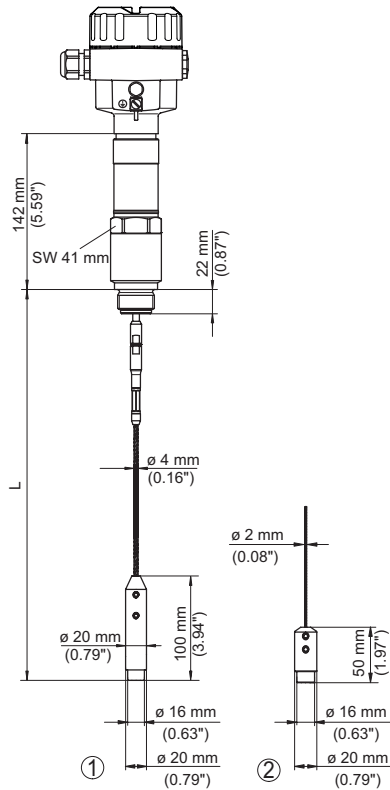

Fig. 12: NivoGuide 8200, threaded version with gravity weight (all gravity weights with thread M8 for eye-bolt)

- L Sensor length, see chapter "Technical data"
- 1 Cable \varnothing 4 mm (0.157 in)
- 2 Cable \varnothing 2 mm (0.079 in)
- 3 Max. height of the vessel insulation

Technical data

NivoGuide 8200, cable version with centering weight

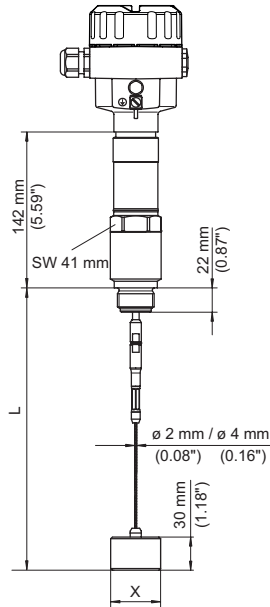

Fig. 13: NivoGuide 8200, threaded version with centering weight

L Sensor length, see chapter "Technical data"

x \varnothing 40 mm (1.57 in)

\varnothing 45 mm (1.77 in)

\varnothing 75 mm (2.95 in)

\varnothing 95 mm (3.74 in)

(see supplementary instructions manual "Centering")

1 Max. height of the vessel insulation

Technical data

NivoGuide 8200, rod version

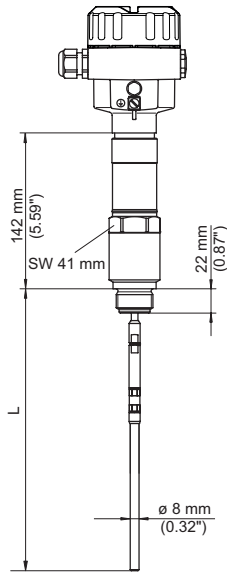

Fig. 14: NivoGuide 8200, threaded version

L Sensor length, see chapter "Technical data"

1 Max. height of the vessel insulation

Mounting

Screwing in

General instructions

Devices with threaded fitting are screwed into the process fitting with a suitable wrench via the hexagon.

See chapter "*Dimensions*" for wrench size.



Warning:

The housing or the electrical connection may not be used for screwing in! Depending on the device version, tightening can cause damage, e. g. to the rotation mechanism of the housing.

Protection against moisture

Protect your instrument against moisture ingress through the following measures:

- Use a suitable connection cable (see chapter "*Connecting to power supply*")
- Tighten the cable gland or plug connector
- Lead the connection cable downward in front of the cable entry or plug connector

This applies mainly to outdoor installations, in areas where high humidity is expected (e.g. through cleaning processes) and on cooled or heated vessels.



Note:

Make sure that during installation or maintenance no moisture or dirt can get inside the instrument.

To maintain the housing protection, make sure that the housing lid is closed during operation and locked, if necessary.

Cable glands

Metric threads

In the case of instrument housings with metric thread, the cable glands are screwed in at the factory. They are sealed with plastic plugs as transport protection.

You have to remove these plugs before electrical connection.

NPT thread

In the case of instrument housings with self-sealing NPT threads, it is not possible to have the cable entries screwed in at the factory. The free openings for the cable glands are therefore covered with red dust protection caps as transport protection. The dust protection caps do not provide sufficient protection against moisture.

Prior to setup you have to replace these protective caps with approved cable glands or close the openings with suitable blind plugs.

Process conditions



Note:

For safety reasons, the instrument must only be operated within the permissible process conditions. You can find

Mounting

detailed information on the process conditions in chapter "*Technical data*" of the operating instructions or on the type label.

Hence make sure before mounting that all parts of the instrument exposed to the process are suitable for the existing process conditions.

These are mainly:

- Active measuring component
- Process fitting
- Process seal

Process conditions in particular are:

- Process pressure
- Process temperature
- Chemical properties of the medium
- Abrasion and mechanical influences

Mounting instructions

Installation position

Mount the device in such a way that the distance to vessel installations or to the vessel wall is at least 300 mm (12 in). In non-metallic vessels, the distance to the vessel wall should be at least 500 mm (19.7 in).

During operation, the probe must not touch any installations or the vessel wall. If necessary, fasten the probe end.

In vessels with conical bottom it can be advantageous to mount the device in the center of the vessel, as measurement is then possible nearly down to the lowest point of the bottom. Keep in mind that measurement all the way down to the tip of the probe may not be possible. The exact value of the min. distance (lower blocking distance) is stated in chapter "*Technical data*".

Mounting

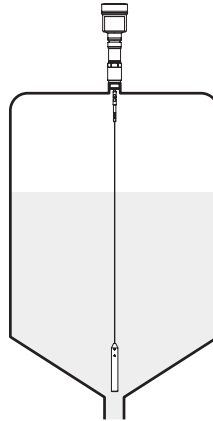

Fig. 15: Vessel with conical bottom

Type of vessel

Plastic vessel/Glass vessel

The guided microwave principle requires a metallic surface on the process fitting. Therefore, in plastic vessels, etc., use an instrument version with flange (from DN 50) or place a metal sheet ($\varnothing > 200$ mm/8 in) beneath the process fitting when screwing it in.

Make sure that the plate has direct contact with the process fitting.

When mounting rod or cable probes in vessels without metal walls, e.g. in plastic vessels, the measured value can be influenced by strong electromagnetic fields (emitted interference according to EN 61326: class A). In this case, use a probe with coaxial version.

Mounting

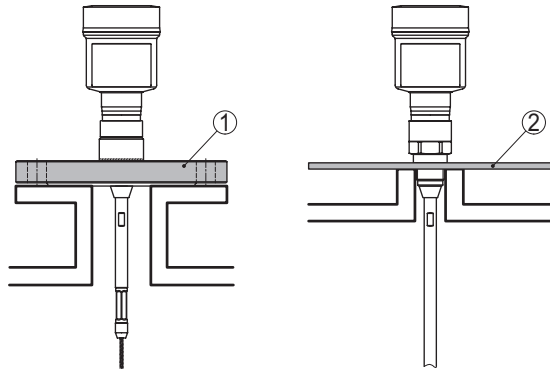

Fig. 16: Mounting in non-metallic vessel

- 1 Flange
- 2 Metal sheet

Nozzle

If possible, avoid nozzles. Mount the sensor flush with the vessel top. If this is not possible, use short nozzles with small diameter.

Higher nozzles or nozzles with a bigger diameter can generally be used. They can, however, increase the upper blocking distance. Check if this is relevant for your measurement.

In such cases, always carry out a false signal suppression after mounting. You can find further information under "Setup procedure".

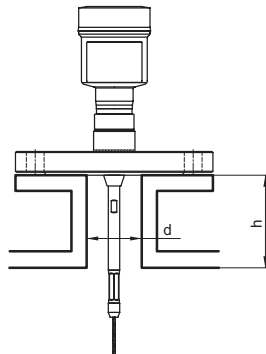

d	h
DN40 ... DN150	≤ 150 mm (5.91")
> DN150 ... DN200	≤ 100 mm (3.94")

Fig. 17: Mounting socket

When welding the nozzle, make sure that the nozzle is flush with the vessel top.

Mounting

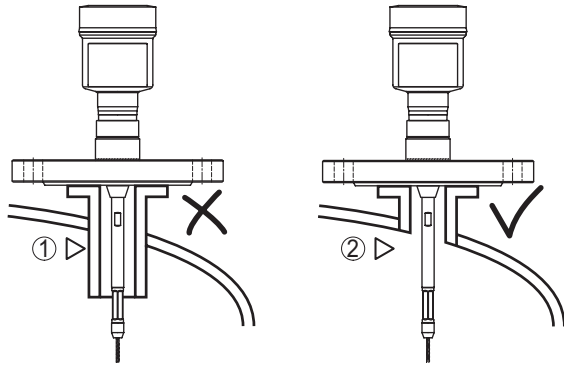

Fig. 18: Nozzle must be installed flush

- 1 Unfavourable mounting
- 2 Nozzle flush - optimum mounting

Welding work

Before beginning the welding work, remove the electronics module from the sensor. By doing this, you avoid damage to the electronics through inductive coupling.

Inflowing medium

Do not mount the instruments in or above the filling stream. Make sure that you detect the medium surface, not the inflowing product.

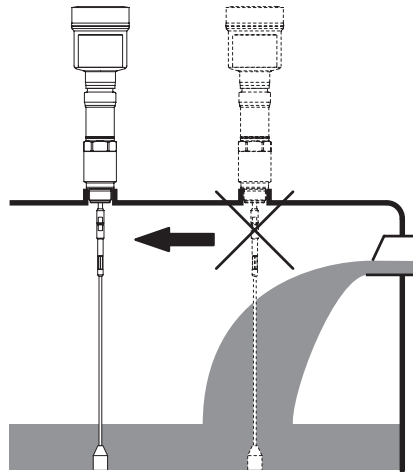

Fig. 19: Mounting of the sensor with inflowing medium

Mounting

Measuring range

The reference plane for the measuring range of the sensors is the sealing surface of the thread or flange.

Keep in mind that a min. distance must be maintained below the reference plane and possibly also at the end of the probe - measurement in these areas is not possible (blocking distance). The length of the cable can be used all the way to the end only when measuring conductive products. These blocking distances for different mediums are listed in chapter "Technical data". Keep in mind for the adjustment that the default setting for the measuring range refers to water.

Pressure

The process fitting must be sealed if there is gauge or low pressure in the vessel. Before use, check if the sealing material is resistant against the measured product and the process temperature.

The max. permissible pressure is specified in chapter "Technical data" or on the type label of the sensor.

Bypass tubes

Standpipes or bypass tubes are normally metal tubes with a diameter of 30 ... 200 mm (1.18 ... 7.87 in). Up to a diameter of 80 mm (3.15 in) such a tube corresponds to a coax measuring probe. Lateral inlets in bypass tubes do not influence the measurement.

Measuring probes can be mounted in bypass tubes up to DN 200.

For bypass tubes, select the probe length such that the blocking distance of the probe is above and below the lower lateral filling openings of the bypass tube. You can thus measure the complete range of the medium in the bypass tube (h). When designing the bypass tube, keep the blocking distance of the probe in mind and select the length of the bypass tube above the upper lateral filling opening accordingly.

Microwaves can penetrate many plastics. This is why plastic tubes are problematic for measurement applications. If durability is no problem, we recommend the use of uncoated metal standpipes.

When the NivoGuide 8200 is used in bypass tubes, contact with the tube wall must be avoided. We recommend for this purpose a cable probe with centering weight.



Caution:

When mounting, make sure that the cable is straight over its entire length. A kink in the cable can cause measurement errors and contact with the tube.

With rod probes, a spacer is generally not required. However, if there is a risk of the rod probe being pressed against the tube wall by inflowing medium, you should mount a spacer

Mounting

at the probe end to avoid contact with the tube wall. In the case of cable probes, the cable can be strained.

Keep in mind that the lower blocking distance underneath the spacer increases if spacers are used.

Buildup can form on the spacers. Strong buildup can influence the measurement.

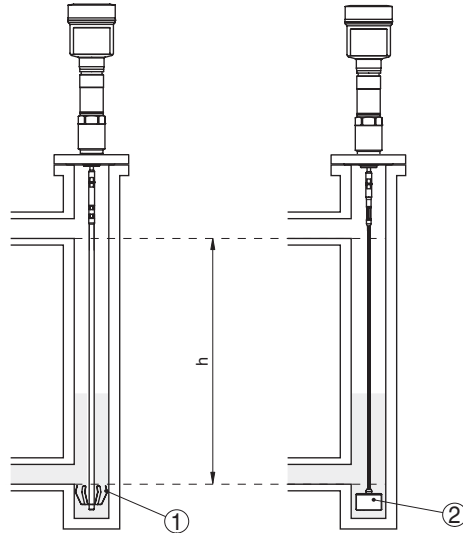

Fig. 20: Mounting in a bypass tube - Position of the spacer or the centering weight

- 1 Rod probe with spacer (steel)
- 2 Cable probe with centering weight
- h Measurable tube section



Note:

Measurement in a standpipe is not recommended for extremely adhesive products. In case of slight buildup, you should choose a bypass tube with bigger diameter.

Instructions for the measurement:

- The 100 % point in bypass tubes should be below the upper tube connection to the vessel.
- The 0 % point in bypass tubes should be above the lower tube connection to the vessel.
- A false signal suppression with installed sensor is generally recommended to achieve the best possible accuracy.

Mounting

Standpipes

Standpipes or surge pipes are normally metal tubes with a diameter of 30 ... 200 mm (1.18 ... 7.87 in). Up to a diameter of 80 mm (3.15 in), such a pipe corresponds to a coax measuring probe. It does not matter if the standpipe is perforated or slotted for better mixing.

Measuring probes can be mounted in standpipes up to DN 200.

For standpipes, select the probe length such that the upper blocking distance of the probe is above the upper ventilation hole. This allows you to measure the total level range of the medium in the standpipe. When designing the standpipe, keep the upper blocking distance of the probe in mind and plan the length above the upper lateral filling opening accordingly.

Microwaves can penetrate many plastics. This is why plastic tubes are problematic for measurement applications. If durability is no problem, we recommend the use of uncoated metal standpipes.

When the NivoGuide 8200 is used in standpipes, contact with the tube wall must be avoided. We recommend for this purpose a cable probe with centering weight.



Caution:

When mounting, make sure that the cable is straight over its entire length. A kink in the cable can cause measurement errors and contact with the tube.

With rod probes, a spacer is generally not required. However, if there is a risk of the rod probe being pressed against the tube wall by inflowing medium, you should mount a spacer at the probe end to avoid contact with the tube wall. In the case of cable probes, the cable can be strained.

Keep in mind that the lower blocking distance underneath the spacer increases if spacers are used.

Buildup can form on the spacers. Strong buildup can influence the measurement.

Mounting

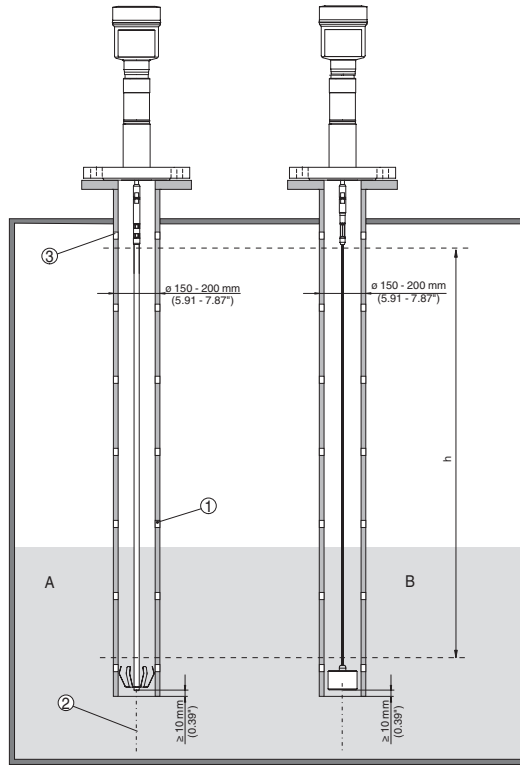

Fig. 21: Mounting in a standpipe

- 1 Holes (for mixing)
- 2 Standpipe - vertically mounted - max. deviation 10 mm (0.4 in)
- 3 Ventilation opening
- A Rod probe with spacer (steel)
- B Cable probe with centering weight



Note:

Measurement in a standpipe is not recommended for extremely adhesive products. In case of slight buildup, you should choose a standpipe with bigger diameter.

Instructions for the measurement:

- The 100 % point with standpipes should be below the upper ventilation hole.
- The 0 % point in standpipes should be above the gravity or centering weight.
- A false signal suppression with installed sensor is generally recommended to achieve the best possible accuracy.

Mounting

Mounting in the vessel insulation

Instruments for a temperature range up to +250 °C (482 °F) have a spacer between process fitting and electronics housing. This spacer is used to thermally decouple the electronics from the high process temperatures.



Information:

The spacer may be incorporated in the vessel insulation up to max. 50 mm (1.97 in). Only then is a reliable temperature decoupling guaranteed.

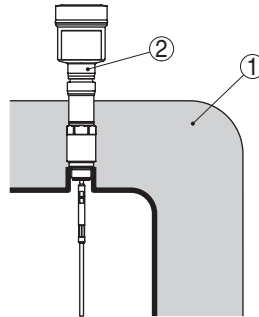

Fig. 22: Mounting the instrument on insulated vessels.

- 1 Temperature insulation
- 2 Ambient temperature on the housing

Fasten

If there is a risk of the cable probe touching the vessel wall during operation due to product movements or agitators, etc., the measuring probe should be securely fixed.

In the gravity weight there is an internal thread (M8), e.g. for an eye-bolt (optional) - (article no. 2.1512).

Make sure that the probe cable is not completely taut. Avoid tensile loads on the cable.

Avoid undefined vessel connections, i.e. the connection must be either grounded reliably or isolated reliably. Any undefined change of this condition can lead to measurement errors.

If there is a danger of the rod probe touching the vessel wall, fasten the probe at the bottom end.

Keep in mind that measurement is not possible below the fastening point.

Mounting

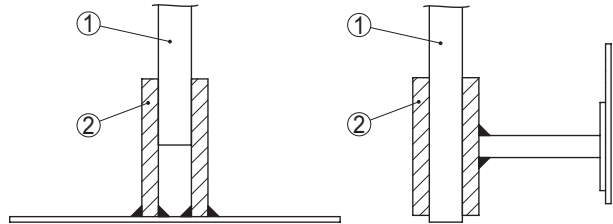

Fig. 23: Fasten the probe

- 1 Measuring probe
- 2 Retaining sleeve

Fixing facility

If there is a risk of the cable probe touching the vessel wall during operation due to product movements or agitators, etc., the measuring probe can be strained.

For this purpose there is an internal thread (M12 or M8) in the gravity weight.

Make sure that the probe cable is only hand tight. Avoid strong tensile loads on the cable.

Keep in mind that measurement is only possible up to the tensioning component. For this reason, order the cable probe 270 mm longer.

$$L = L1 + 270 \text{ mm (10.63 in)}$$

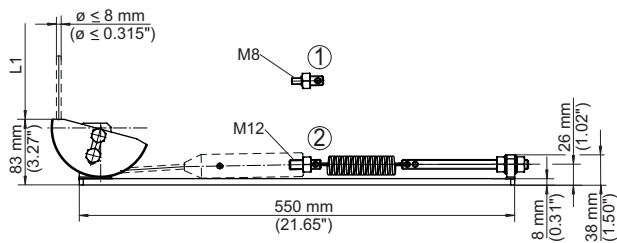

Fig. 24: Tensioning component for cable versions

- 1 Holding screw M8
 - 2 Holding screw M12
- L1 Max. measuring length
 Probe length $L = L1 + 270 \text{ mm (10.63 in)}$

Lateral installation

In case of difficult installation conditions, the probe can also be mounted laterally. For this, adapt the rod with rod extensions or angled segments.

To compensate for the resulting changes in signal runtime, let the instrument determine the probe length automatically.

The determined probe length can deviate from the actual probe length when using curved or angled segments.

Mounting

If internal installations such as struts, ladders, etc. are present on the vessel wall, the measuring probe should be mounted at least 300 mm (11.81 in) away from the vessel wall.

You can find further information in the supplementary instructions of the rod extension.

Connecting to power supply and bus system

Safety instructions

Preparing the connection

Always keep in mind the following safety instructions:

- Carry out electrical connection by trained, qualified personnel authorised by the plant operator
- If overvoltage surges are expected, overvoltage arresters should be installed



Warning:

Only connect or disconnect in de-energized state.

Voltage supply

The instrument requires an operating voltage of 8 ... 30 V DC. Operating voltage and digital bus signal are carried on separate two-wire connection cables.



Note:

Power the instrument via an energy-limited circuit (power max. 100 W) acc. to IEC 61010-1, e.g.

- Class 2 power supply unit (acc. to UL1310)
- SELV power supply unit (safety extra-low voltage) with suitable internal or external limitation of the output current

Connection cable

The instrument is connected with standard two-wire, twisted cable suitable for RS 485. If electromagnetic interference is expected which is above the test values of EN 61326 for industrial areas, shielded cable should be used.

Use cable with round cross section for instruments with housing and cable gland. Use a cable gland suitable for the cable diameter to ensure the seal effect of the cable gland (IP protection rating).

Make sure that the entire installation is carried out according to the Fieldbus specification. In particular, make sure that the bus is terminated with suitable terminating resistors.

Cable glands

Metric threads:

In the case of instrument housings with metric thread, the cable glands are screwed in at the factory. They are sealed with plastic plugs as transport protection.



Note:

You have to remove these plugs before electrical connection.

NPT thread:

In the case of instrument housings with self-sealing NPT threads, it is not possible to have the cable entries screwed in at the factory. The free openings for the cable glands are therefore covered with red dust protection caps as transport protection.

Connecting to power supply and bus system



Note:

Prior to setup you have to replace these protective caps with approved cable glands or close the openings with suitable blind plugs.

On plastic housings, the NPT cable gland or the Conduit steel tube must be screwed into the threaded insert without grease.

Max. torque for all housings, see chapter "*Technical data*".

Cable screening and grounding

Make sure that the cable screen and grounding are carried out according to Fieldbus specification. We recommend to connect the cable screening to ground potential on both ends.

In systems with potential equalisation, connect the cable screening directly to ground potential at the power supply unit and the sensor. The cable screening in the sensor must be connected directly to the internal ground terminal. The ground terminal outside on the housing must be connected to the potential equalisation (low impedance).

Connecting

Connection technology

The voltage supply and signal output are connected via the spring-loaded terminals in the housing.

Connection to the display and adjustment module or to the interface adapter is carried out via contact pins in the housing.



Information:

The terminal block is pluggable and can be removed from the electronics. To do this, lift the terminal block with a small screwdriver and pull it out. When reinserting the terminal block, you should hear it snap in.

Connection procedure

Proceed as follows:

1. Unscrew the housing lid
2. If a display and adjustment module is installed, remove it by turning it slightly to the left
3. Loosen compression nut of the cable gland and remove blind plug
4. Remove approx. 10 cm (4 in) of the cable mantle, strip approx. 1 cm (0.4 in) of insulation from the ends of the individual wires
5. Insert the cable into the sensor through the cable entry

Connecting to power supply and bus system



Fig. 25: Connection steps 5 and 6 - Single chamber housing

6. Insert the wire ends into the terminals according to the wiring plan



Information:

Solid cores as well as flexible cores with wire end sleeves are inserted directly into the terminal openings. In case of flexible cores without end sleeves, press the terminal from above with a small screwdriver, the terminal opening is then free. When the screwdriver is released, the terminal closes again.

You can find further information on the max. wire cross-section under "*Technical data - Electromechanical data*".

7. Check the hold of the wires in the terminals by lightly pulling on them
8. Connect the shielding to the internal ground terminal, connect the external ground terminal to potential equalisation
9. Tighten the compression nut of the cable entry gland. The seal ring must completely encircle the cable
10. Reinsert the display and adjustment module, if one was installed
11. Screw the housing lid back on

The electrical connection is finished.

Connecting to power supply and bus system

Wiring plan - single chamber housing

Wiring plan - Daisy-Chain



Information:

With Modbus systems, several sensors can be connected in parallel. With this so called "Daisy-Chain" the cables for the signal and voltage supply are looped from sensor to sensor. The last sensor in this "chain" must be provided with a bus termination. For this purpose there is a connectable terminating resistor on the electronics module. Make sure that the slid switch (5) with all sensors of the chain is set to "off". With the last sensor you have to set the slide switch (5) to position "on".

Please also take note of the information in the annex "Basics Modbus".

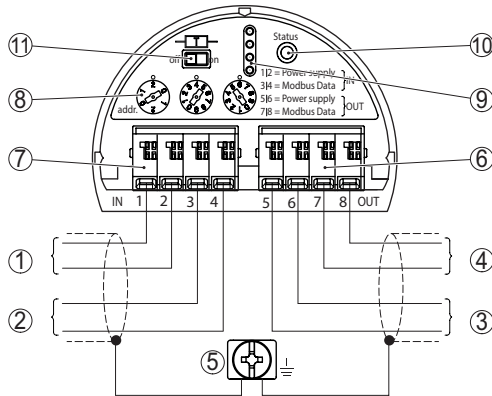

Fig. 26: Electronics compartment - Connection Daisy-Chain

- 1 Voltage supply
- 2 Signal input
- 3 Power supply (to further Modbus sensors)
- 4 Signal output (to further Modbus sensors)
- 5 Ground terminal in the housing
- 6 Terminal block - Output (OUT)
- 7 Terminal block - Input (IN)
- 8 Rotary switch for address setting
- 9 Contacts for the display and adjustment module or the interface adapter
- 10 Signal lamp - Status
- 11 Connectable bus resistor

Wiring plan - Stub

While connecting the sensor to a stub, the arrangement of the resistor is undefined.

Thus the connection via stub is generally possible, however not recommended.

Connecting to power supply and bus system

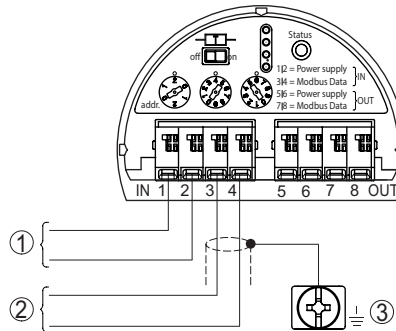

Fig. 27: Electronics compartment - Connection with stub

- 1 Voltage supply
- 2 Signal output
- 3 Ground terminal in the housing

Set instrument address

Instrument address

An address must be assigned to each Modbus instrument. The approved addresses are between 000 and 247. Each address must only be assigned once in the Modbus network. The sensor is only recognized by the control system if the address is set correctly.

You can assign a hardware address to the instrument with the rotary switches on the electronics module. However, it is also possible to allocate a software address. For this purpose, the instrument must be set to a certain hardware address. With Modbus, this is hardware address 246, with Levelmaster the hardware addresses of 31 ... 299. If you want to allocate the instrument address via software, we recommend keeping hardware address set to 246.

When the instrument is shipped, address 246 is set by default (hardware address 246, software address). This address can be used to test the function of the instrument and to connect it to a Modbus network. Then the address must be changed to integrate additional instruments.

The address setting is carried out either via:

- The address selection switch in the electronics module of the instrument (address setting via hardware)
- The display and adjustment module (address setting via software)
- PACTware/DTM (address setting via software)

Hardware addressing

The instrument recognizes automatically by means of the input data if a Modbus or Levelmaster protocol is available.

Connecting to power supply and bus system

The hardware addressing with Modbus is effective if an address less or equal 245 is set with the address selection switches on the instrument. Software addressing is then no longer effective, the set hardware address applies.

The hardware addressing with Levelmaster protocol is effective if an address less or equal 30 is set with the address selection switches on the instrument. Software addressing is then no longer effective, the set hardware address applies.

Available hardware addresses:

- Hardware address - Levelmaster: 000 ... 030
- Hardware address - Modbus: 000 ... 245

Set the instrument address with the three rotary switches on the electronics module.

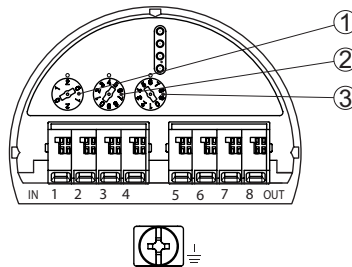

Fig. 28: Address selection switch

- 1 Hundreds digit of the address (selection 0 to 2)
- 2 Decade of the address (selection 0 to 9)
- 3 Unit position of the address (selection 0 to 9)

Software addressing

The software addressing for Modbus is effective if address 246 is set with the address selection switches on the instrument. Address 247 is an additional hardware address.

With the Levelmaster protocol the software addressing is effective if address 031 or higher is set on the instrument with the address selection switches.

You can set the instrument address with the display and adjustment module or with the software PACTware/DTM.

Available software addresses:

- Software address - Levelmaster: When hardware address ≥ 031 is set, addresses 000 ... 031 can be selected by the software
- Software address - Modbus: When hardware address 246 is set, addresses 000 ... 246 can be selected by the software

Connecting to power supply and bus system

Switch-on phase

After connecting NivoGuide 8200 to the bus system, the device first performs a self-test:

- Internal check of the electronics
- Indication of the status message "*F 105 Determine measured value*" on the display or PC
- Status byte goes to fault value

Then the actual measured value is output to the signal cable. The value takes into account settings that have already been carried out, e.g. default setting.

Set up the sensor with the display and adjustment module

Adjustment volume

The display and adjustment module is only used for parameter adjustment of the sensor, i.e. for adaptation to the measurement task.

The parameter adjustment of the Modbus interface is carried out via a PC with PACTware. You can find the procedure in chapter "Set up sensor and Modbus interface with PACTware".

Insert display and adjustment module

The display and adjustment module can be inserted into the sensor and removed again at any time. You can choose any one of four different positions - each displaced by 90°. It is not necessary to interrupt the power supply.

Proceed as follows:

1. Unscrew the housing lid
 2. Place the display and adjustment module on the electronics in the desired position and turn it to the right until it snaps in.
 3. Screw housing lid with inspection window tightly back on
- Disassembly is carried out in reverse order.

The display and adjustment module is powered by the sensor, an additional connection is not necessary.



Fig. 29: Insertion of the display and adjustment module with single chamber housing



Note:

If you intend to retrofit the instrument with a display and adjustment module for continuous measured value indication, a higher lid with an inspection glass is required.

Set up the sensor with the display and adjustment module

Adjustment system

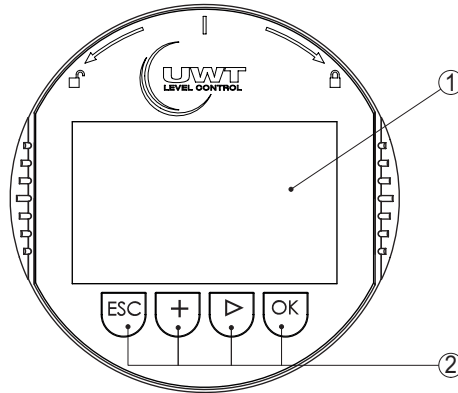

Fig. 30: Display and adjustment elements

- 1 LC display
- 2 Adjustment keys

Key functions

- **[OK]** key:
 - Move to the menu overview
 - Confirm selected menu
 - Edit parameter
 - Save value
- **[->]** key:
 - Change measured value presentation
 - Select list entry
 - Select editing position
- **[+]** key:
 - Change value of the parameter
- **[ESC]** key:
 - Interrupt input
 - Jump to next higher menu

Adjustment system

The instrument is operated via the four keys of the display and adjustment module. The individual menu items are shown on the LC display. You can find the function of the individual keys in the previous illustration.

Adjustment system - keys via magnetic pen

With the Bluetooth version of the display and adjustment module you can also adjust the instrument with the magnetic pen. The pen operates the four keys of the display and adjustment module right through the closed lid (with inspection window) of the sensor housing.

Set up the sensor with the display and adjustment module

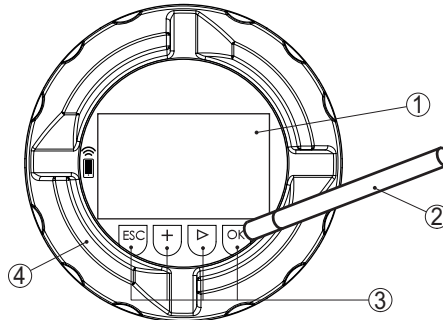

Fig. 31: Display and adjustment elements - with adjustment via magnetic pen

- 1 LC display
- 2 Magnetic pen
- 3 Adjustment keys
- 4 Lid with inspection window

Time functions

When the **[+]** and **[->]** keys are pressed quickly, the edited value, or the cursor, changes one value or position at a time. If the key is pressed longer than 1 s, the value or position changes continuously.

When the **[OK]** and **[ESC]** keys are pressed simultaneously for more than 5 s, the display returns to the main menu. The menu language is then switched over to "English".

Approx. 60 minutes after the last pressing of a key, an automatic reset to measured value indication is triggered. Any values not confirmed with **[OK]** will not be saved.

Switch-on phase

After switching on, the NivoGuide 8200 carries out a short self-test where the device software is checked.

The output signal transmits a fault signal during the switch-on phase.

The following information is displayed on the display and adjustment module during the startup procedure:

- Instrument type
- Device name
- Software version (SW-Ver)
- Hardware version (HW-Ver)

Measured value indication

With the **[->]** key you move between three different indication modes:

In the first view, the selected measured value is displayed in large digits.

Set up the sensor with the display and adjustment module

In the second view, the selected measured value and a respective bargraph presentation are displayed.

In the third view, the selected measured value as well as a second selectable value, e.g. the temperature, are displayed.



Parameter adjustment - Quick setup

Quick setup

To quickly and easily adapt the sensor to the application, select the menu item "Quick setup" in the start graphic on the display and adjustment module.

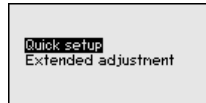

The following steps for the quick setup can be reached also in the "Extended adjustment".

- Instrument address
- Measurement loop name
- Medium type (optional)
- Application
- Max. adjustment
- Min. adjustment
- False signal suppression

You can find the description of the individual menu items in the following chapter "Parameter adjustment - Extended adjustment".

Parameter adjustment - Extended adjustment

For technically demanding measuring points, you can carry out extended settings in "Extended adjustment".

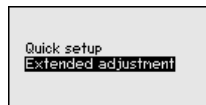

Main menu

The main menu is divided into five sections with the following functions:

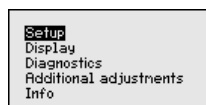

Set up the sensor with the display and adjustment module

Setup: Settings, e.g. measurement loop name, medium, vessel, adjustment, signal output, device unit, false signal suppression, linearization curve

Display: Settings, e.g., for language, measured value display, lighting

Diagnosis: Information, e.g. on instrument status, peak indicator, measurement reliability, simulation, echo curve

Additional adjustments: Reset, date/time, reset, copy function

Info: Instrument name, hardware and software version, date of manufacture, instrument features



Note:

For optimum setting of the measuring point, the individual submenu items in the main menu item "Setup" should be selected one after the other and provided with the correct parameters. If possible, go through the items in the given sequence.

The procedure is described below.

The following submenu points are available:

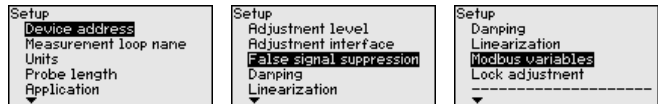

The submenu points are described below.

7.5.1 Setup

Instrument address

An address must be assigned to each Modbus instrument. Each address may only be assigned once in the Modbus or Levelmaster network. The sensor is only recognized by the control system if the address is set correctly.

- Permitted address range - Modbus 0 ... 247
- Permitted address range - Levelmaster 0 ... 31

In delivery status, Modbus address 246 and Levelmaster address 31 are set by default. Hence the software addressing is possible by default.

The address setting is carried out either via:

- The address selection switch in the electronics compartment of the instrument (hardware addressing)
- The display and adjustment module (software addressing)
- PACTware/DTM (software addressing)

Hardware addressing

Hardware addressing is effective if a Modbus address of 0 ... 245 is set with the address selection switches on the electronics module of NivoGuide 8200. In such case, software

Set up the sensor with the display and adjustment module

addressing has no effect - only the set hardware address applies (Levelmaster addresses: 0 ... 30).

Software addressing

Software addressing is only effective if address address 246 or higher is set on the instrument with the address selection switches (Levelmaster address: 31).



Information:

You can find detailed information to adjust the instrument address in chapter "**Connecting to power supply**"

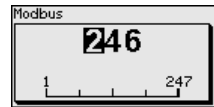

Measurement loop name

Here you can assign a suitable measurement loop name. Push the "OK" key to start the editing. With the "+" key you change the sign and with the "->" key you jump to the next position.

You can enter names with max. 19 characters. The character set comprises:

- Capital letters from A ... Z
- Numbers from 0 ... 9
- Special characters + - / _ blanks

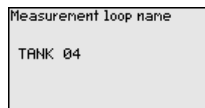

Units

In this menu item you select the distance unit and the temperature unit.

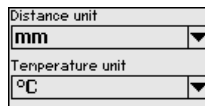

For the distance units you can choose between m, mm and ft and for the temperature units °C, °F and K.

Probe length

In this menu item you can enter the probe length or have the length determined automatically by the sensor system.

When choosing "Yes", then the probe length will be determined automatically. When choosing "No", you can enter the probe length manually.

Set up the sensor with the display and adjustment module

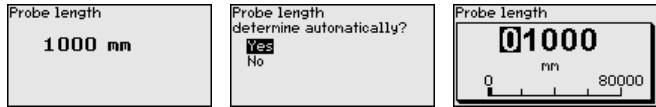

Application - Medium type

In this menu item you can select which type of medium you want to measure. You can choose between liquid or bulk solid.

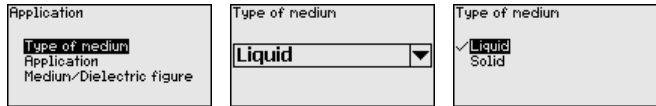

Application - Application

In this menu item, you can select the application. You can choose between level measurement and interface measurement. You can also choose between measurement in a vessel or in a bypass or standpipe.



Note:

The selection of the application has a considerable influence on all other menu items. Keep in mind that as you continue with the parameter adjustment, individual menu items are only optionally available.

You have the option of choosing the demonstration mode. This mode is only suitable for test and demonstration purposes. In this mode, the sensor ignores the parameters of the application and reacts immediately to any change.

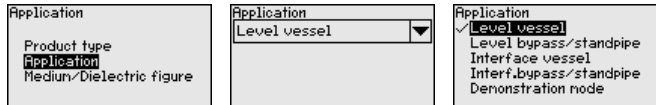

Application - Medium, dielectric constant

In this menu item, you can define the type of medium (product).

This menu item is only available if you have selected level measurement under the menu item "Application".

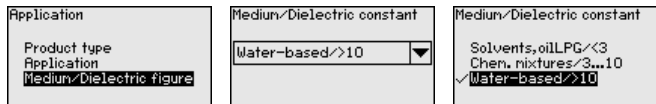

You can choose between the following medium types:

Dielectric constant	Type of medium	Examples
> 10	Water-based liquids	Acids, alcalis, water

Set up the sensor with the display and adjustment module

Dielectric constant	Type of medium	Examples
3 ... 10	Chemical mixtures	Chlorobenzene, nitro lacquer, aniline, isocyanate, chloroform
< 3	Hydrocarbons	Solvents, oils, liquid gas

Application - Gas phase

This menu item is only available, if you have chosen interface measurement under the menu item "Application". In this menu item you can enter if there is a superimposed gas phase in your application.

Only set the function to "Yes", if the gas phase is permanently present.

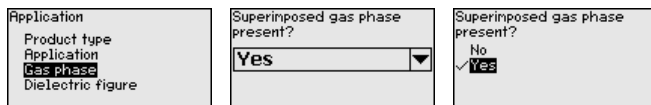

Application - Dielectric constant

This menu item is only available if you have selected interface measurement under the menu item "Application". In this menu item you can enter the dielectric constant of the upper medium.

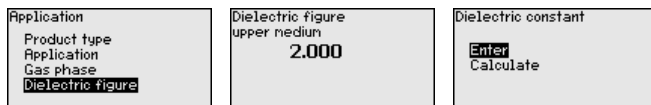

You can directly enter the dielectric constant of the upper medium or have the value determined by the instrument.

If you want the dielectric constant to be determined by the instrument, you have to enter the measured or known distance to the interface.



Note:

The dielectric constant can only be reliably determined if two different media and a sufficiently large interface are present.

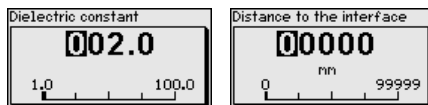

Max. adjustment - Level

In this menu item you can enter the max. adjustment for the level. With interface measurement this is the maximum total level.

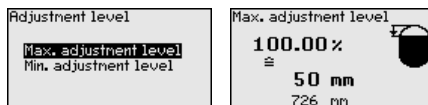

Set up the sensor with the display and adjustment module

Adjust the requested percentage value with **[+]** and store with **[OK]**.

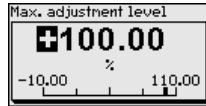

Enter the appropriate distance value in m (corresponding to the percentage value) for the full vessel. The distance refers to the sensor reference plane (seal surface of the process fitting). Keep in mind that the max. level must lie below the blocking distance.

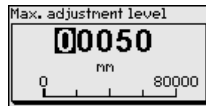

Min. adjustment - Level

In this menu item you can enter the min. adjustment for the level. With interface measurement this is the minimum total level.

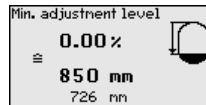
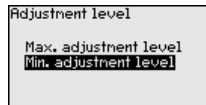

Adjust the requested percentage value with **[+]** and store with **[OK]**.

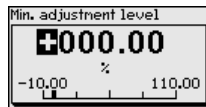

Enter the suitable distance value in m for the empty vessel (e.g. distance from the flange to the probe end) corresponding to the percentage value. The distance refers to the sensor reference plane (seal surface of the process fitting).

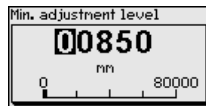

Max. adjustment - Interface

This menu item is only available if you have selected interface measurement under the menu item "Application".

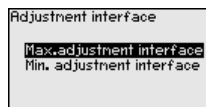

Enter the requested percentage value for the max. adjustment.

Set up the sensor with the display and adjustment module

As an alternative, you have the possibility taking over the adjustment of the level measurement also for the interface.

Enter the respective distance value in m for the surface of the upper medium corresponding to the percentage value.

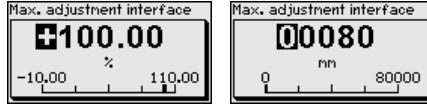

Min. adjustment - Interface

This menu item is only available if you have selected interface measurement under the menu item "Application".

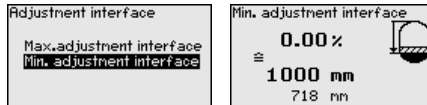

Enter the requested percentage value for the min. adjustment (interface).

Enter the respective distance value in m for the interface corresponding to the percentage value of the interface.

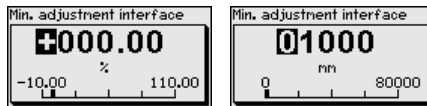

False signal suppression

The following circumstances cause interfering reflections and can influence the measurement:

- High mounting nozzles
- Vessel internals such as struts



Note:

A false signal suppression detects, marks and saves these false signals so that they are no longer taken into account for the level and interface measurement. We generally recommend carrying out a false signal suppression to achieve the best possible accuracy. This should be done with the lowest possible level so that all potential interfering reflections can be detected.

Proceed as follows:

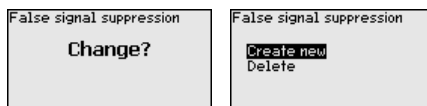

Select first if the probe is covered or uncovered.

If the probe is covered, enter the actual distance from the sensor to the product surface.

Set up the sensor with the display and adjustment module

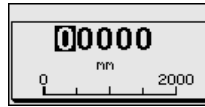
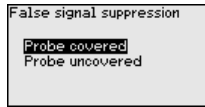

All interfering signals in this section are detected by the sensor and stored.

Keep in mind that with covered probe only false signals in the uncovered area of the probe are detected.



Note:

Check the distance to the medium surface, because if an incorrect (too large) value is entered, the existing level will be saved as a false signal. The level would then no longer be detectable in this area.

If a false signal suppression has already been saved in the sensor, the following menu window appears when selecting "False signal suppression":

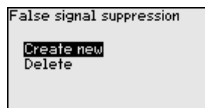

The instrument carries out an automatic false signal suppression as soon as the probe is uncovered. The false signal suppression is always updated.

The menu item "Delete" is used to completely delete an already created false signal suppression. This is useful if the saved false signal suppression no longer matches the metrological conditions in the vessel.

Damping

To damp process-dependent measured value fluctuations, you can set a time of 0 ... 999 s in this menu item.

If you have selected interface measurement under the menu item "Application", you can adjust the damping for the level and the interface separately.

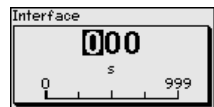
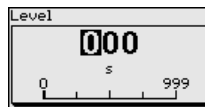
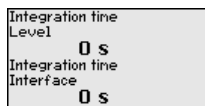

The default setting is a damping of 0 s.

Linearisation

A linearisation is necessary for all vessels in which the vessel volume does not increase linearly with the level, e.g. a horizontal cylindrical or spherical tank, when the indication or output of the volume is required. Corresponding linearisation curves are preprogrammed for these vessels. They represent the correlation between the level percentage and vessel volume.

Set up the sensor with the display and adjustment module

The linearisation applies to the measured value indication and the output. By activating the appropriate curve, the volume percentage of the vessel is displayed correctly. If the volume should not be displayed in percent but e.g. in l or kg, a scaling can be also set in the menu item "Display".

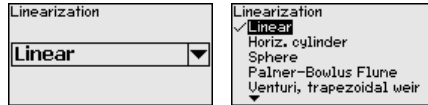

Warning:

If a linearisation curve is selected, the measuring signal is no longer necessarily linear to the filling height. This must be considered by the user especially when setting the switching point on the limit signal transmitter.

In the following, you have to enter the values for your vessel, for example the vessel height and the socket correction.

For non-linear vessel forms, enter the vessel height and the socket correction.

For the vessel height, you have to enter the total height of the vessel.

For the nozzle correction you have to enter the height of the nozzle above the upper edge of the vessel. If the nozzle is lower than the upper edge of the vessel, this value can also be negative.

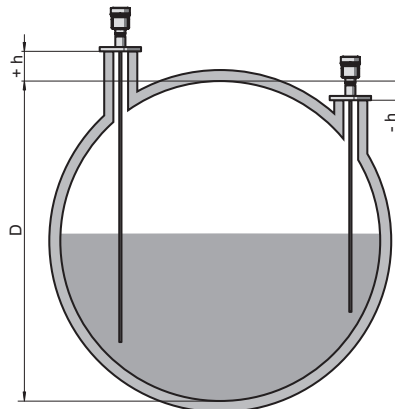
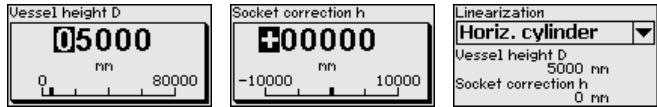

Fig. 32: Vessel height and socket correction value

- D Vessel height
- +h Positive socket correction value
- h Negative socket correction value

Set up the sensor with the display and adjustment module



Modbus variables

In this menu item, all Modbus variables of the outputs were collected.

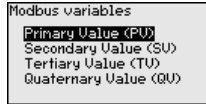

Primary Value ... Quarternary Value

In the menu items "Primary Value" to "Quarternary Value" you determine which measured value to output refers to.

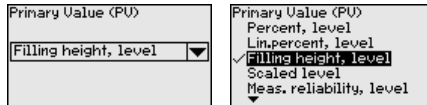

Lock/Unlock adjustment

In the menu item "Lock/unlock adjustment", you can protect the sensor parameters against unauthorized or inadvertent modification. The PIN is activated/deactivated permanently.

With active PIN, only the following adjustment functions are possible without entering a PIN:

- Select menu items and show data
- Read data from the sensor into the display and adjustment module

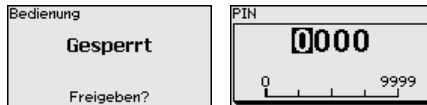

Caution:

When the PIN is active, adjustment via PACTware/DTM as well as other systems is also blocked.

In delivery status, the PIN is **0000**.

Call our service department if you have modified and forgotten the PIN.

7.5.2 Display

In the main menu point "Display", the individual submenu points should be selected one after the other and provided with the correct parameters to ensure the optimum adjustment of the display. The procedure is described in the following.

The following submenu points are available:

Set up the sensor with the display and adjustment module

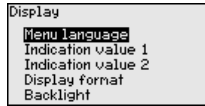

The submenu points are described below.

Menu language

This menu item enables the setting of the requested national language.

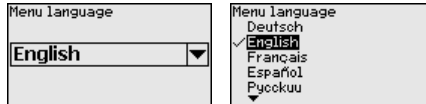

In delivery status, the sensor is set to English.

Displayed value 1

In this menu item, you define the indication of the measured value on the display. You can display two different measured values. In this menu item, you define measured value 1.

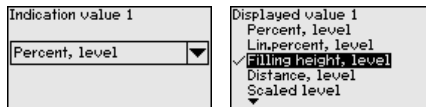

The default setting for the displayed value 1 is "Filling height Level".

Displayed value 2

In this menu item, you define the indication of the measured value on the display. You can display two different measured values. In this menu item, you define measured value 2.

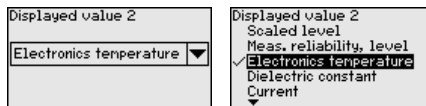

The default setting for the displayed value 2 is the electronics temperature.

Display format

In this menu item, you define the display format of the measured value on the display. You can define different display formats for the two measured values.

You can thus define the number of decimal positions the measured value is displayed with.

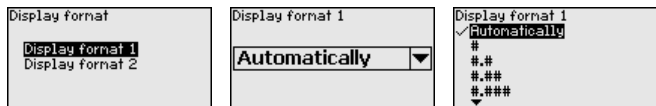

The default setting for the display format is "Automatic".

Set up the sensor with the display and adjustment module

Backlight

The integrated background lighting can be switched off via the adjustment menu. The function depends on the strength of the operating voltage, see "*Technical data*".

To maintain the function of the device, the lighting is temporarily switched off if the power supply is insufficient.



In delivery status, the lighting is switched on.

7.5.3 Diagnostics

Device status

In this menu item, the device status is displayed.

When the instrument displays a fault signal, you can here get detailed information on the failure reason.

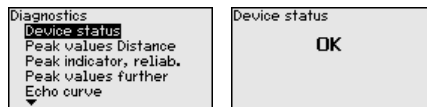

Peak indicator, distance

The respective min. and max. measured value is saved in the sensor. The two values are displayed in the menu item "*Peak indicator, distance*".

If you have selected interface measurement under the menu item "*Setup - Application*", the peak values of the interface measurement are displayed in addition to the peak values of the level measurement.

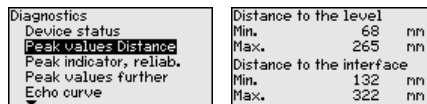

In another window you can carry out a reset of the two peak values separately.

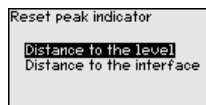

Peak indicator, measurement reliability

The respective min. and max. measured values are saved in the sensor. The two values are displayed in the menu item "*Peak indicator, measurement reliability*".

The measurement can be influenced by the process conditions. In this menu item, the measurement reliability of the level measurement is displayed in mV. The higher the value, the more reliable the measurement.

Set up the sensor with the display and adjustment module

If you have selected interface measurement under the menu item "Setup - Application", the peak values of the interface measurement are displayed in addition to the peak values of the level measurement.

Diagnostics Device status Peak values Distance Peak indicator, reliab. Peak values further Echo curve ▼	Meas. reliability, level Min. 1 nV Max. 279 nV Meas. reliability, interface Min. 1 nV Max. 316 nV
---	--

In another window you can carry out a reset of the two peak values separately.

Reset peak indicator Meas. reliability, level Meas. reliab. interface

Peak indicator, additional

The respective min. and max. measured values are saved in the sensor. The values are displayed in the menu item "Peak indicator Additional".

This menu item displays the peak values of the electronics temperature as well as the dielectric constant.

Diagnostics Peak values Distance Peak indicator, reliab. Peak values further Echo curve Simulation ▼	Electronics temperature Min. 27.28 °C Max. 28.84 °C Dielectric constant Min. 1.00 Max. 1.00
--	--

In another window you can carry out a reset of the two peak values separately.

Reset peak indicator Electronics temperature Dielectric constant
--



Information:

If one of the display values flashes, there is actually no valid value available.

Echo curve

The menu item "Echo curve" shows the signal strength of the echoes over the measuring range in V. The signal strength enables an evaluation of the quality of the measurement.

Diagnostics Peak indicator, reliab. Peak values further Echo curve Simulation Echo curve memory ▼	Echo curve
---	----------------

With the following functions you can zoom part sections of the echo curve.

- "X-Zoom": Zoom function for the meas. distance
- "Y-Zoom": 1, 2, 5 and 10x signal magnification in "V"

Set up the sensor with the display and adjustment module

- "Unzoom": Reset the presentation to the nominal measuring range without magnification

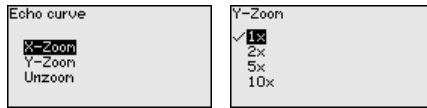

Simulation

In this menu item you can simulate measured values via the output. This allows the signal path to be tested, e.g. through downstream indicating instruments or the input card of the control system.

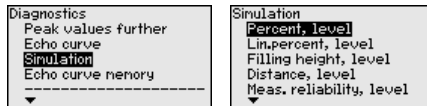

Select the requested simulation variable and set the requested value.

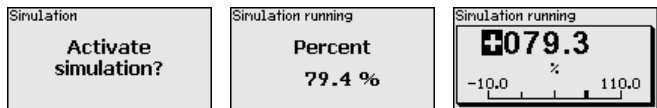

Push the **[ESC]** key to deactivate the simulation.



Information:

The simulation is terminated automatically 60 minutes after the activation of the simulation.

Echo curve memory

With the menu item "Setup" the echo curve it is possible to save at the time of setup. This is generally recommended; for using the Asset Management functions it is necessary. If possible, the curve should be saved with a low level in the vessel.

With this, you can detect signal changes over the operating time. With the adjustment software PACTware and the PC, the high-resolution echo curve can be displayed and used to compare the echo curve of the setup with the actual echo curve.



The function "Echo curve memory" enables storing echo curves of the measurement.

Under the sub-menu item "Echo curve memory" you can store the current echo curve.

Set up the sensor with the display and adjustment module

Parameter settings for recording the echo curve and the settings of the echo curve itself can be carried out in the adjustment software PACTware.

With the adjustment software PACTware and the PC the high-resolution echo curve can be displayed and used later on to assess the quality of the measurement.

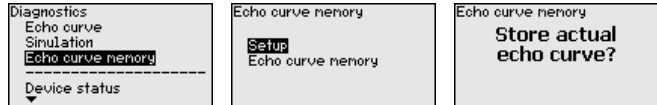

7.5.4 Additional adjustments

Date/Time

In this menu item, the internal clock of the sensor is set.

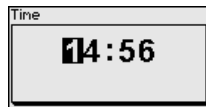
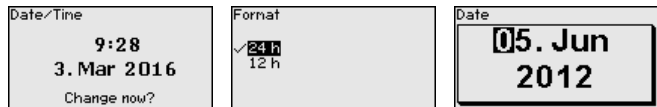

Reset

After a reset, certain parameter adjustments made by the user are reset.



Note:

After this menu window, the reset process is carried out. No further safety inquiry follows.

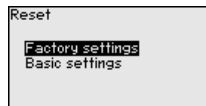

The following reset functions are available:

Delivery status: Restores the parameter settings at the time of shipment from the factory, incl. order-specific settings. Any stored false signal suppression or user-programmed linearization curve, as well as the measured value memory, are deleted.

Basic settings: Resetting of the parameter settings incl. special parameters to the default values (presettings) of the respective instrument. Any created false signal suppression or user-programmable linearization curve as well as the measured value memory are deleted.

The following table shows the default values of the instrument. Depending on the instrument version or application, all

Set up the sensor with the display and adjustment module

menu items may not be available or some may be differently assigned:

Menu - Setup

Menu item	Default value
Lock adjustment	Released
Measurement loop name	Sensor
Units	Distance unit: order-specific Temperature unit: order-specific
Probe length	Länge der Messsonde factory setting
Type of medium	Liquid
Application	Level in the vessel
Medium, dielectric constant	Water-based, > 10
Superimposed gas phase	Yes
Dielectric constant, upper medium (TS)	1.5
Tube inner diameter	200 mm
Max. adjustment - Level	100 %
Max. adjustment - Level	Distance: 0.000 m(d) - note blocking distances
Min. adjustment - Level	0 %
Min. adjustment - Level	Distance: Probe length - take dead band into account
Accept adjustment of the level measurement?	No
Max. adjustment - Interface	100 %
Max. adjustment - Interface	Distance: 0.000 m(d) - note blocking distances
Min. adjustment - Interface	0 %
Min. adjustment - Interface	Distance: Probe length - take dead band into account
Damping - Level	0.0 s
Damping - Interface	0.0 s
Linearization type	Linear
Linearisation - Socket correction	0 mm
Linearisation - Vessel height	Probe length

Set up the sensor with the display and adjustment module

Menu - Display

Menu item	Default value
Language	Selected language
Displayed value 1	Filling height - Level
Displayed value 2	Electronics temperature
Backlight	Switched on

Menu - Diagnosis

Menu item	Default value
Status signals - Function control	Switched on
Status signals - Out of specification	Switched off
Status signals - Maintenance required	Switched off
Device memory - Echo curve memory	Stopped
Device memory - Measured value memory	Started
Device memory - Measured value memory - Measured values	Distance level, percentage value level, reliability level, electronics temperature
Device memory - Measured value memory - Recording in time interval	3 min.
Device memory - Measured value memory - Recording with measured value difference	15 %
Device memory - Measured value memory - Start with measured value	Not active
Device memory - Measured value memory - Stop with measured value	Not active
Device memory - Measured value memory - Stop recording when memory is full	Not active

Menu - Additional adjustments

Menu item	Default value
PIN	0000
Date	Actual date
Time	Actual time
Time - Format	24 hours
Probe type	Device-specific

Set up the sensor with the display and adjustment module

Copy instrument settings

The instrument settings are copied with this function. The following functions are available:

- **Read from sensor:** Read data from sensor and store into the display and adjustment module
- **Write into sensor:** Store data from the display and adjustment module back into the sensor

The following data or settings for adjustment of the display and adjustment module are saved:

- All data of the menu "Setup" and "Display"
- In the menu "Additional adjustments" the items "Reset, Date/Time"
- Special parameters

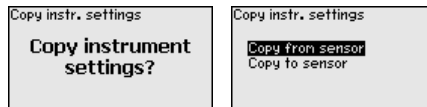

Prerequisites

The following requirements must be met for a successful transmission:

- The data can only be transferred to the same device type, e.g. NivoGuide 8200
- It must be the same probe type, e.g. rod probe
- The firmware of both devices is identical

The copied data are permanently saved in an EEPROM memory in the display and adjustment module and remain there even in case of power failure. From there, they can be written into one or more sensors or kept as backup for a possible electronics exchange.



Note:

Before the data are stored in the sensor, a check is carried out to determine if the data fit the sensor. If the data do not fit, a fault signal is triggered or the function is blocked. When data are being written into the sensor, the display shows which instrument type the data originate from and which TAG number this sensor had.



Tip:

We recommend to save the instrument adjustments. In case of an electronics exchange the saved parameter adjustment data relieve this process.

Scaling level

Since scaling is very extensive, scaling of the level value was divided into two menu items.

Set up the sensor with the display and adjustment module

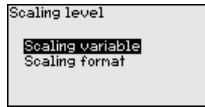

Scaling level - Scaling prime

In menu item "Scaling variable" you define the scaling variable and the scaling unit for the level value on the display, e.g. volume in l.

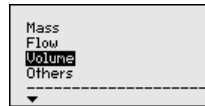
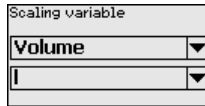

Scaling interface

Since scaling is very extensive, scaling of the interface value was divided into two menu items.

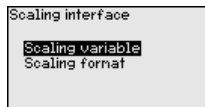

Scaling interface - Scaling size

In menu item "Scaling variable" you define the scaling variable and the scaling unit for the interface value on the display, e.g. volume in l.

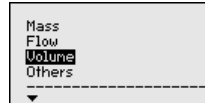
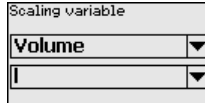

Probe type

In this menu item you can select the type and size of your probe from a list of all possible probes. This is necessary to adapt the electronics optimally to the probe.

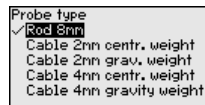
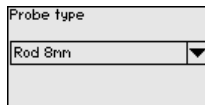

Interface

In this menu item, all settings of the instrument interfaces are collected.

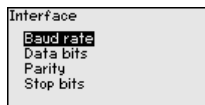

Baudrate

in this menu item you determine with which transmission speed the operates.

The adjustable Baud rate is in the range of 1200 ... 57600.

Set up the sensor with the display and adjustment module

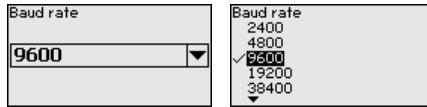

Data bits

In this menu item you determine how many data bits per Baud are transmitted.

You can chose between 7 and 8 bits.

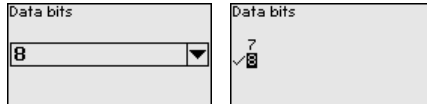

Parity

In this menu item you can select if and how an extension bit can be added.

You can chose between even and odd parity or no change.

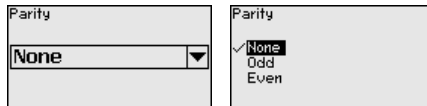

Stop bits

In this menu item you can select how many stop bits are added for synchronization.

You can chose between 1 or 2 stop bits.

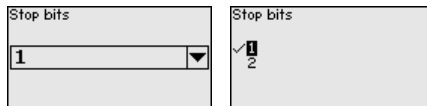

Modbus

In this menu item, all settings of the instrument interfaces are collected.

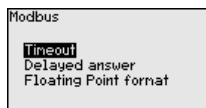

Timeout

in this menu item you determine from which time the sensor interrupts a measured value transmission.



Response delay

in this menu item you determine with which time delay in response the sensor operates.

Set up the sensor with the display and adjustment module

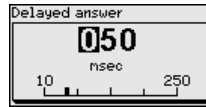
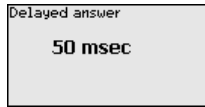

Floating point format

in this menu item you determine with which bit sequence the sensor operates.

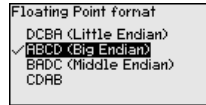
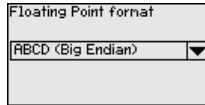

Levelmaster

In this menu item, all settings of the Levelmaster are collected.

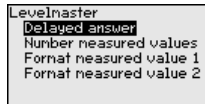

Response delay

in this menu item you determine with which time delay in response the sensor operates.

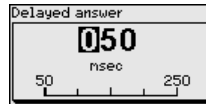
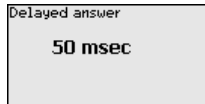

Number of measured values

In this menu item you determine how many measured values are displayed.

You can have either one or two measured values displayed.

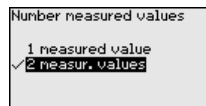
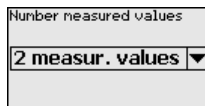

Format measured value 1

In this menu item you specify the display format of the display for measured value 1.

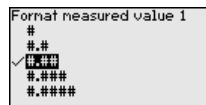
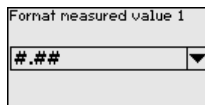

Format measured value 2

In this menu item you specify the display format of the display for measured value 2.

Set up the sensor with the display and adjustment module

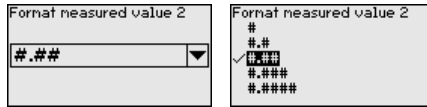

Special parameters

In this menu item you gain access to the protected area where you can enter special parameters. In exceptional cases, individual parameters can be modified in order to adapt the sensor to special requirements.

Change the settings of the special parameters only after having contacted our service staff.



7.5.5 Info

Device name

In this menu, you read out the instrument name and the instrument serial number.

Instrument version

In this menu item, the hardware and software version of the sensor is displayed.



Factory calibration date

In this menu item, the date of factory calibration of the sensor as well as the date of the last change of sensor parameters are displayed via the display and adjustment module or via the PC.

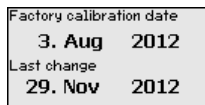

Sensor characteristics

In this menu item, the features of the sensor such as approval, process fitting, seal, measuring range, electronics, housing and others are displayed.

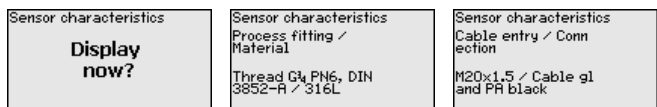

Example for displayed sensor features.

Set up the sensor with the display and adjustment module

Save parameter adjustment data

On paper

We recommended writing down the adjustment data, e.g. in this instructions manual, and archiving them afterwards. They are thus available for multiple use or service purposes.

In the display and adjustment module

If the instrument is equipped with a display and adjustment module, the parameter adjustment data can be saved therein. The procedure is described in menu item "*Copy device settings*".

Diagnosis, asset management and service

	Maintenance
Maintenance	If the device is used properly, no special maintenance is required in normal operation.
Cleaning	<p>The cleaning helps that the type label and markings on the instrument are visible.</p> <p>Take note of the following:</p> <ul style="list-style-type: none">• Use only cleaning agents which do not corrode the housings, type label and seals• Use only cleaning methods corresponding to the housing protection rating
	Measured value and event memory
	<p>The instrument has several memories available for diagnostic purposes. The data remain there even in case of voltage interruption.</p>
Measured value memory	<p>Up to 100,000 measured values can be stored in the sensor in a ring memory. Each entry contains date/time as well as the respective measured value. Storable values are for example:</p> <ul style="list-style-type: none">• Distance• Filling height• Percentage value• Lin. percent• Scaled• Current value• Measurement reliability• Electronics temperature <p>When the instrument is shipped, the measured value memory is active and stores distance, measurement reliability and electronics temperature every 3 minutes.</p> <p>In "Extended adjustment" you can select the respective measured values.</p> <p>The requested values and recording conditions are set via a PC with PACTware/DTM or the control system with EDD. Data are thus read out and also reset.</p>
Event memory	<p>Up to 500 events are automatically stored with a time stamp in the sensor (non-deletable). Each entry contains date/time, event type, event description and value.</p> <p>Event types are for example:</p> <ul style="list-style-type: none">• Modification of a parameter• Switch-on and switch-off times• Status messages (according to NE 107)• Error messages (according to NE 107)

Diagnosis, asset management and service

The data are read out via a PC with PACTware/DTM or the control system with EDD.

Echo curve memory

The echo curves are stored with date and time and the corresponding echo data. The memory is divided into two sections:

Echo curve of the setup: This is used as reference echo curve for the measurement conditions during setup. Changes in the measurement conditions during operation or buildup on the sensor can thus be recognized. The echo curve of the setup is stored via:

- PC with PACTware/DTM
- Control system with EDD
- Display and adjustment module

Further echo curves: Up to 10 echo curves can be stored in a ring buffer in this memory section. Additional echo curves are stored via:

- PC with PACTware/DTM
- Control system with EDD
- Display and adjustment module

Asset Management function

The instrument features self-monitoring and diagnostics according to NE 107 and VDI/VDE 2650. In addition to the status messages in the following tables there are more detailed error messages available under the menu item "Diagnostics" via the respective adjustment module.

Status messages

The status messages are divided into the following categories:

- Failure
- Function check
- Out of specification
- Maintenance required

and explained by pictographs:

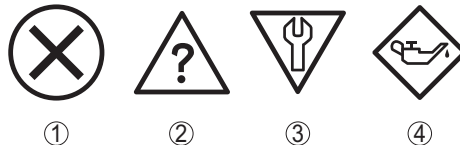

Fig. 33: Pictographs of the status messages

- 1 Failure - red
- 2 Out of specification - yellow
- 3 Function check - orange
- 4 Maintenance required - blue

Diagnosis, asset management and service

Malfunction (Failure):

Due to a malfunction in the instrument, a fault signal is output.

This status message is always active. It cannot be deactivated by the user.

Function check:

The instrument is being worked on, the measured value is temporarily invalid (for example during simulation).

This status message is inactive by default.

Out of specification:

The measured value is unreliable because an instrument specification was exceeded (e.g. electronics temperature).

This status message is inactive by default.

Maintenance required:

Due to external influences, the instrument function is limited. The measurement is affected, but the measured value is still valid. Plan in maintenance for the instrument because a failure is expected in the near future (e.g. due to buildup).

This status message is inactive by default.

Failure (failure)

Code Text message	Cause	Rectification	DevSpec Diagnosis Bits
F013 no measured value available	Sensor does not detect an echo during operation Antenna system dirty or defective	Check for correct mounting and/or parameter adjustment Clean or exchange process component or antenna	Bit 0
F017 Adjustment span too small	Adjustment not within specification	Change adjustment according to the limit values (difference between min. and max. ≥ 10 mm)	Bit 1
F025 Error in the linearization table	Index markers are not continuously rising, for example illogical value pairs	Check linearization table Delete table/Create new	Bit 2
F036 No operable software	Failed or interrupted software update	Repeat software update Check electronics version Exchanging the electronics Send instrument for repair	Bit 3
F040 Error in the electronics	Hardware defect	Exchanging the electronics Send instrument for repair	Bit 4
F041 Probe loss	Cable probe broken or rod probe defective	Check probe and exchange, if necessary	Bit 13

Diagnosis, asset management and service

Code Text message	Cause	Rectification	DevSpec Diagnosis Bits
F080 General software error	General software error	Disconnect operating voltage briefly	Bit 5
F105 Measured value is determined	The instrument is still in the switch-on phase, the measured value could not yet be determined	Wait for the end of the switch-on phase Duration up to approx. 3 minutes depending on the version and parameter settings	Bit 6
F113 Communication error	Error in the internal instrument communication	Disconnect operating voltage briefly Send instrument for repair	-
F125 Impermissible electronics temperature	Temperature of the electronics in the non-specified range	Check ambient temperature Insulate electronics Use instrument with higher temperature range	Bit 7
F260 Error in the calibration	Error in the calibration carried out in the factory Error in the EEPROM	Exchanging the electronics Send instrument for repair	Bit 8
F261 Error in the instrument settings	Error during setup False signal suppression faulty Error when carrying out a reset	Repeat setup Repeat reset	Bit 9
F264 Installation/ Setup error	Adjustment not within the vessel height/measuring range Max. measuring range of the instrument not sufficient	Check for correct mounting and/or parameter adjustment Use an instrument with bigger measuring range	Bit 10
F265 Measurement function disturbed	Sensor no longer carries out a measurement Operating voltage too low	Check operating voltage Carry out a reset Disconnect operating voltage briefly	Bit 11
F266 Impermissible operating voltage	Wrong operating voltage	Check operating voltage Check connection cables	Bit 14
F267 No executable sensor software	Sensor cannot start	Exchanging the electronics Send instrument for repair	-

Tab. 9: Error codes and text messages, information on causes as well as corrective measures

Diagnosis, asset management and service

Function check

Code Text message	Cause	Rectification	DevSpec State in CMD 48
C700 Simulation active	A simulation is active	Finish simulation Wait for the automatic end after 60 mins.	"Simulation Active" in "Standardized Status 0"

Tab. 10: Error codes and text messages, information on causes as well as corrective measures

Out of specification

Code Text message	Cause	Rectification	DevSpec State in CMD 48
S600 Impermissible electronics temperature	Temperature of the processing electronics in the non-specified section	Check ambient temperature Insulate electronics Use instrument with higher temperature range	Bit 8 of Byte 14 ... 24
S601 Overfilling	Level echo in the close range not available	Reduce level 100 % adjustment: Increase value Check mounting socket Remove possible interfering signals in the close range Use coaxial probe	Bit 9 of Byte 14 ... 24
S602 Level within the search range, compensation echo	Compensation echo superimposed by medium	100 % adjustment: Increase value	Bit 10 of Byte 14 ... 24
S603 Impermissible operating voltage	Operating voltage below specified range	Check electrical connection If necessary, increase operating voltage	Bit 11 of Byte 14 ... 24

Tab. 11: Error codes and text messages, information on causes as well as corrective measures

Maintenance

Code Text message	Cause	Rectification	DevSpec State in CMD 48
M500 Error in the delivery status	The data could not be restored during the reset to delivery status	Repeat reset Load XML file with sensor data into the sensor	Bit 0 of Byte 14 ... 24

Diagnosis, asset management and service

Code Text message	Cause	Rectification	DevSpec State in CMD 48
M501 Error in the non-active linearisation table	Index markers are not continuously rising, for example illogical value pairs	Check linearization table Delete table/Create new	Bit 1 of Byte 14 ... 24
M504 Error at a device interface	Hardware defect	Exchanging the electronics Send instrument for repair	Bit 4 of Byte 14 ... 24
M505 no measured value available	Sensor does not detect an echo during operation	Check and correct mounting and/or parameter adjustment	Bit 5 of Byte 14 ... 24
	Process component or probe contaminated or defective	Clean or exchange process component or probe	
M506 Installation/ Setup error	Error during setup	Check and correct mounting and/or parameter adjustment Check probe length	Bit 6 of Byte 14 ... 24
M507 Error in the instrument settings	Error during setup Error when carrying out a reset False signal suppression faulty	Carry out reset and repeat setup	Bit 7 of Byte 14 ... 24

Tab. 12: Error codes and text messages, information on causes as well as corrective measures

Rectify faults

Reaction when malfunction occurs

The operator of the system is responsible for taking suitable measures to rectify faults.

Fault rectification

The first measures are:

- Evaluation of fault messages
- Checking the output signal
- Treatment of measurement errors

Treatment of measurement errors

The below tables show typical examples for application-relevant measurement errors. There are two measurement errors:

- Constant level
- Filling
- Emptying

The images in column "Error pattern" show the real level as a broken line and the level displayed by the sensor as a continuous line.

Diagnosis, asset management and service

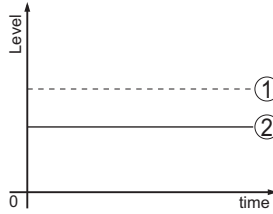

Fig. 34: The broken line 1 shows the real level, the continuous line 2 shows the level displayed by the sensor



Note:

If the output level is constant, the cause could also be the fault setting of the output to "Hold value".



If the level is too low, the reason could be a line resistance that is too high

Measurement error with constant level

Fault description	Cause	Rectification
Measured value shows a too low or too high level 	Min./max. adjustment not correct	Adapt min./max. adjustment
	Incorrect linearization curve	Adapt linearization curve
	Running time error (small measurement error close to 100 %/serious error close to 0 %)	Repeat setup
Measured value jumps towards 100 % 	Due to the process, the amplitude of the product echo decreases A false signal suppression was not carried out	Carry out a false signal suppression
	Amplitude or position of a false signal has changed (e.g. buildup); false signal suppression no longer matches	Determine the reason for the changed false signals, carry out false signal suppression, e.g. with buildup

Diagnosis, asset management and service

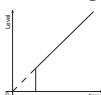
Measurement error during filling

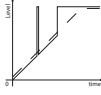
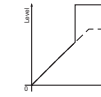
Fault description	Cause	Rectification
Measured value remains in the area of the bottom during filling 	Echo from the probe end larger than the product echo, for example, with products with $\rho_f < 2.5$ oil-based, solvents, etc.	Check parameter "Medium" and "Vessel height", adapt if necessary
Measured value remains momentarily unchanged during filling and then jumps to the correct level 	Turbulence on the medium surface, quick filling	Check parameters, change if necessary, e.g. in dosing vessel, reactor
Measured value jumps sporadically to 100 % during filling 	Changing condensation or contamination on the probe	Carry out a false signal suppression
Measured value jumps to $\geq 100\%$ or 0 m distance 	Level echo is no longer detected in the close range due to false signals in the close range. The sensor goes into overfill protection mode. The max. level (0 m distance) as well as the status message "Overfill protection" are output.	Eliminate false signals in the close range Check installation conditions If possible, switch off the function "Overfill protection"

Measurement error during emptying

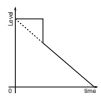
Fault description	Cause	Rectification
Measured value remains unchanged in the close range during emptying 	False signal larger than the level echo Level echo too small	Eliminate false signals in the close range Remove contamination on the probe. After having removed the source of the false signals, the false signal suppression must be deleted. Carry out a new false signal suppression

Diagnosis, asset management and service

Fault description	Cause	Rectification
Measured value remains reproducible in one position during emptying 	Stored false signals in this position are larger than the level echo	Delete false signal suppression Carry out a new false signal suppression

Reaction after fault rectification

Depending on the reason for the fault and the measures taken, the steps described in chapter "Setup" must be carried out again or must be checked for plausibility and completeness.

Exchanging the electronics module

If the electronics module is defective, it can be replaced by the user.



In Ex applications, only instruments and electronics modules with appropriate Ex approval may be used.

If there is no electronics module available on site, the electronics module can be ordered through the agency serving you. The electronics modules are adapted to the respective sensor and differ in signal output or voltage supply.

The new electronics module must be loaded with the default settings of the sensor. These are the options:

- In the factory
- Or on site by the user

In both cases, the serial number of the sensor is needed. The serial numbers are stated on the type label of the instrument, on the inside of the housing as well as on the delivery note.

When loading on site, the order data must first be downloaded from the Internet (see operating instructions "Electronics module").



Information:

All application-specific settings must be entered again. That's why you have to carry out a fresh setup after exchanging the electronics.

If you saved the parameter settings during the first setup of the sensor, you can transfer them to the replacement electronics module. A fresh setup is then not necessary.

Diagnosis, asset management and service

Exchanging the cable/ rod

Exchange or shorten cable/rod

The cable or rod (meas. part) of the probe can be shortened, if necessary. To loosen the rod or cable you need a fork spanner with spanner width 13.

1. Loosen the rod or cable by applying a fork spanner to the flat surfaces (SW 13), provide counterforce with another fork spanner (SW 13)
2. Unscrew the loosened rod or cable manually.
3. Place the enclosed new double washer onto the thread.



Caution:

Make sure that the two components of the double washer remain together.

4. Screw the new rod and the new cable manually to the thread on the process fitting.
5. Exert counterforce with the second fork spanner and tighten the measuring rod or cable on the flat surfaces with a torque of 20 Nm (15 lbf ft).

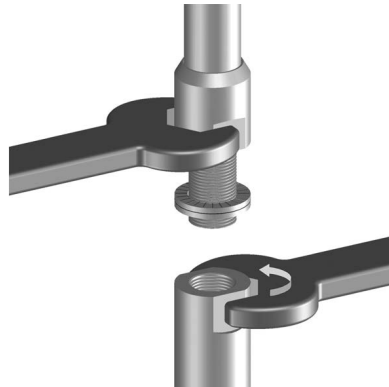

Fig. 35: Exchange cable or rod



Information:

Please maintain the specified torque so that the max. tensile strength of the connection remains.

6. Enter new probe length and if necessary the new probe type and then carry out a fresh adjustment (see "Setup procedure, Carrying out min. adjustment - Carrying out max. adjustment").

Shorten cable/rod

The rod or cable of the probe can be shortened individually.

1. Mark the requested length with mounted measuring rod.
2. Cable: Loosen the pins on the gravity weight (hexagon 3)

Diagnosis, asset management and service

3. Cable: remove the pins
4. Cable: Pull the cable out of the gravity weight
5. Shorten the cable/rod with a cut-off wheel or metal saw at the marking. Take note of the specifications in the following illustration when shortening the cable.
6. Cable with gravity weight: Shift the cable according to the drawing into the gravity weight
7. Cable with gravity weight: Fasten cable with the pins, torque 7 Nm (5.16 lbf ft)

Cable with centering weight: Fasten cable with the pins, torque 7 Nm (5.16 lbf ft) and fix the clamping part on the centering weight.

8. Enter new probe length and then carry out a fresh adjustment (see "Setup procedure, Carrying out min. adjustment - Carrying out max. adjustment").

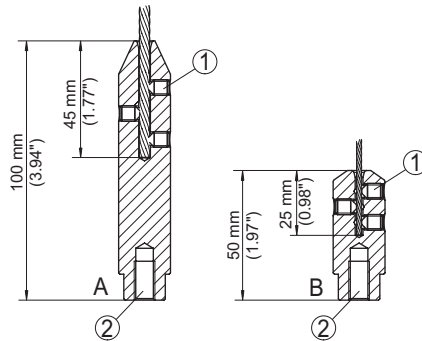

Fig. 36: Shortening the cable probe

- A Gravity weight - cable \varnothing 4 mm
- B Gravity weight - cable \varnothing 2 mm
- C Centering weight - cable \varnothing 2 mm
- 1 Threaded pins
- 2 Thread M8 for eye-bolt
- 3 Fixing screw - centering weight

How to proceed if a repair is necessary

If a repair should be necessary, please contact your contact person.

Dismount

Dismounting steps

To remove the device, carry out the steps in chapters "*Mounting*" and "*Connecting to power supply*" in reverse.



Warning:

When dismantling, pay attention to the process conditions in vessels or pipelines. There is a risk of injury, e.g. due to high pressures or temperatures as well as aggressive or toxic media. Avoid this by taking appropriate protective measures.

Disposal



Pass the instrument on to a specialised recycling company and do not use the municipal collecting points.

Remove any batteries in advance, if they can be removed from the device, and dispose of them separately.

If personal data is stored on the old device to be disposed of, delete it before disposal.

If you have no way to dispose of the old instrument properly, please contact us concerning return and disposal.

Supplement

Device communication Modbus

In the following, the necessary device-specific details are shown. You can find further information of Modbus on www.modbus.org.

Protocol description

The NivoGuide 8200 is suitable for connection to the following RTUs with Modbus RTU or ASCII protocol.

RTU	Protocol
ABB Totalflow	Modbus RTU, ASCII
Bristol ControlWaveMicro	Modbus RTU, ASCII
Fisher ROC	Modbus RTU, ASCII
ScadaPack	Modbus RTU, ASCII
Thermo Electron Autopilot	Modbus RTU, ASCII

Parameters for the bus communication

The NivoGuide 8200 is preset with the default values:

Parameter	Configurable Values	Default Value
Baud Rate	1200, 2400, 4800, 9600, 19200, 38400, 57600	9600
Start Bits	1	1
Data Bits	7, 8	8
Parity	None, Odd, Even	None
Stop Bits	1, 2	1
Address range Modbus	1 ... 255	246

Start bits and data bits cannot be modified.

General configuration of the host

The data exchange with status and variables between field device and host is carried out via register. For this, a configuration in the host is required. Floating point numbers with short prevision (4 bytes) according to IEEE 754 are transmitted with individually selectable order of the data bytes (byte transmission order). This "*Byte transmission order*" is determined in the parameter "*Format Code*". Hence the RTU knows the registers of the NivoGuide 8200 which must be contacted for the variables and status information.

Format Code	Byte transmission order
0	ABCD
1	CDAB

Supplement

Format Code	Byte transmission order
2	DCBA
3	BADC

Modbus register

Holding Register

The Holding registers consist of 16 bit. They can be read and written. Before each command, the address (1 byte), after each command, a CRC (2 byte) is sent.

Register Name	Register Number	Type	Configurable Values	Default Value	Unit
Address	200	Word	1 ... 255	246	–
Baud Rate	201	Word	1200, 2400, 4800, 9600, 19200, 38400, 57600	9600	–
Parity	202	Word	0 = None, 1 = Odd, 2 = Even	0	–
Stopbits	203	Word	1 = One, 2 = Two	1	–
Delay Time	206	Word	10 ... 250	50	ms
Byte Oder (Floating point format)	3000	Word	0, 1, 2, 3	0	–

Input register

The input registers consist of 16 bits. They can only be read. The address (1 byte) is sent before each command, a CRC (2 bytes) after each command. PV, SV, TV and QV can be set via the sensor DTM.

Register Name	Register Number	Type	Note
Status	100	DWord	Bit 0: Invalid Measurement Value PV Bit 1: Invalid Measurement Value SV Bit 2: Invalid Measurement Value TV Bit 3: Invalid Measurement Value QV
PV Unit	104	DWord	Unit Code
PV	106		Primary Variable in Byte Order CDAB
SV Unit	108	DWord	Unit Code
SV	110		Secondary Variable in Byte Order CDAB
TV Unit	112	DWord	Unit Code
TV	114		Third Variable in Byte Order CDAB

Supplement

Register Name	Register Number	Type	Note
QV Unit	116	DWord	Unit Code
QV	118		Quarternary Variable in Byte Order CDAB
Status	1300	DWord	See Register 100
PV	1302		Primary Variable in Byte Order of Register 3000
SV	1304		Secondary Variable in Byte Order of Register 3000
TV	1306		Third Variable in Byte Order of Register 3000
QV	1308		Quarternary Variable in Byte Order of Register 3000
Status	1400	DWord	See Register 100
PV	1402		Primary Variable in Byte Order CDAB
Status	1412	DWord	See Register 100
SV	1414		Secondary Variable in Byte Order CDAB
Status	1424	DWord	See Register 100
TV	1426		Third Variable in Byte Order CDAB
Status	1436	DWord	See Register 100
QV	1438		Quarternary Variable in Byte Order CDAB
Status	2000	DWord	See Register 100
PV	2002	DWord	Primary Variable in Byte Order ABCD (Big Endian)
SV	2004	DWord	Secondary Variable in Byte Order ABCD (Big Endian)
TV	2006	DWord	Third Variable in Byte Order ABCD (Big Endian)
QV	2008	DWord	Quarternary Variable in Byte Order ABCD (Big Endian)
Status	2100	DWord	See Register 100
PV	2102	DWord	Primary Variable in Byte Order DCBA (Little Endian)
SV	2104	DWord	Secondary Variable in Byte Order DCBA (Little Endian)
TV	2106	DWord	Third Variable in Byte Order ABCD DCBA (Little Endian)
QV	2108	DWord	Quarternary Variable in Byte Order DCBA (Little Endian)

Supplement

Register Name	Register Number	Type	Note
Status	2200	DWord	See Register 100
PV	2202	DWord	Primary Variable in Byte Order BACD (Middle Endian)
SV	2204	DWord	Secondary Variable in Byte Order BACD (Middle Endian)
TV	2206	DWord	Third Variable in Byte Order BACD (Middle Endian)
QV	2208	DWord	Quarternary Variable in Byte Order BACD (Middle Endian)

Unit Codes for Register 104, 108, 112, 116

Unit Code	Measurement Unit
32	Degree Celsius
33	Degree Fahrenheit
40	US Gallon
41	Liters
42	Imperial Gallons
43	Cubic Meters
44	Feet
45	Meters
46	Barrels
47	Inches
48	Centimeters
49	Millimeters
111	Cubic Yards
112	Cubic Feet
113	Cubic Inches

Modbus RTU commands

FC3 Read Holding Register

With this command, any number (1-127) of holding registers is read out. The start register, from which the readout should start, and the number of registers are transmitted.

Supplement

	Parameter	Length	Code/Data
Request:	Function Code	1 Byte	0x03
	Start Address	2 Bytes	0x0000 to 0xFFFF
	Number of Registers	2 Bytes	1 to 127 (0x7D)
Response:	Function Code	1 Byte	0x03
	Byte Count	2 Bytes	2*N
	Register Value	N*2 Bytes	Data

FC4 Read Input Register

With this command, any number (1-127) of input registers is read out. The start register, from which the readout should start, and the number of registers are transmitted.

	Parameter	Length	Code/Data
Request:	Function Code	1 Byte	0x04
	Start Address	2 Bytes	0x0000 to 0xFFFF
	Number of Registers	N*2 Bytes	1 to 127 (0x7D)
Response:	Function Code	1 Byte	0x04
	Byte Count	2 Bytes	2*N
	Register Value	N*2 Bytes	Data

FC6 Write Single Register

This function code is used to write to a single Holding Register.

	Parameter	Length	Code/Data
Request:	Function Code	1 Byte	0x06
	Start Address	2 Bytes	0x0000 to 0xFFFF
	Number of Registers	2 Bytes	Data
Response:	Function Code	1 Byte	0x04
	Start Address	2 Bytes	2*N
	Register Value	2 Bytes	Data

FC8 Diagnostics

With this function code different diagnostic functions are triggered or diagnostic values read out.

Supplement

	Parameter	Length	Code/Data
Request:	Function Code	1 Byte	0x08
	Sub Function Code	2 Bytes	
	Data	N*2 Bytes	Data
Response:	Function Code	1 Byte	0x08
	Sub Function Code	2 Bytes	
	Data	N*2 Bytes	Data

Implemented function codes:

Sub Function Code	Name
0x00	Return Data Request
0x0B	Return Message Counter

With sub function codes 0x00 only one 16 bit value can be written.

FC16 Write Multiple Register

This function code is used to write to several Holding Registers. In a request, it can only be written to registers that are in direct succession.

	Parameter	Length	Code/Data
Request:	Function Code	1 Byte	0x10
	Start Address	2 Bytes	0x0000 to 0xFFFF
	Number of Registers	2 Bytes	0x0001 to 0x007B
	Byte Count	1 Byte	2*N
	Register Value	N*2 Bytes	Data
Response:	Function Code	1 Byte	0x10
	Start Address	2 Bytes	0x0000 to 0xFFFF
	Number of Registers	2 Bytes	0x01 to 0x7B

FC17 Report Sensor ID

With this function code, the sensor ID on Modbus is queried.

	Parameter	Length	Code/Data
Request:	Function Code	1 Byte	0x11

Supplement

	Parameter	Length	Code/Data
Response:	Function Code	1 Byte	0x11
	Byte Number	1 Byte	
	Sensor ID	1 Byte	
	Run Indicator Status	1 Byte	

FC43 Sub 14, Read Device Identification

With this function code, the Device Identification is queried.

	Parameter	Length	Code/Data
Request:	Function Code	1 Byte	0x2B
	MEI Type	1 Byte	0x0E
	Read Device ID Code	1 Byte	0x01 to 0x04
	Object ID	1 Byte	0x00 to 0xFF
Response:	Function Code	1 Byte	0x2B
	MEI Type	1 Byte	0x0E
	Read Device ID Code	1 Byte	0x01 to 0x04
	Confirmity Level	1 Byte	0x01, 0x02, 0x03, 0x81, 0x82, 0x83
	More follows	1 Byte	00/FF
	Next Object ID	1 Byte	Object ID number
	Number of Objects	1 Byte	
	List of Object ID	1 Byte	
	List of Object length	1 Byte	
	List of Object value	1 Byte	Depending on the Object ID

Levelmaster commands

The NivoGuide 8200 is also suitable for connection to the following RTUs with Levelmaster protocol. The Levelmaster protocol is often called "*Siemens*" "*Tank protocol*".

RTU	Protocol
ABB Totalflow	Levelmaster

Supplement

RTU	Protocol
Kimray DACC 2000/3000	Levelmaster
Thermo Electron Autopilot	Levelmaster

Parameters for the bus communication

The NivoGuide 8200 is preset with the default values:

Parameter	Configurable Values	Default Value
Baud Rate	1200, 2400, 4800, 9600, 19200	9600
Start Bits	1	1
Data Bits	7, 8	8
Parity	None, Odd, Even	None
Stop Bits	1, 2	1
Address range Levelmaster	32	32

The Levelmaster commands are based on the following syntax:

- Capital letters are at the beginning of certain data fields
- Small letters stand for data fields
- All commands are terminated with "<cr>" (carriage return)
- All commands start with "Uuu", whereby "uu" stands for the address (00-31)
- "*" can be used as a joker for any position in the address. The sensor always converts this in its address. In case of more than one sensor, the joker must not be used, because otherwise several slaves will answer
- Commands that modify the instrument return the command with "OK". "EE-ERROR" replaces "OK" if there was a problem changing the configuration

Report Level (and Temperature)

	Parameter	Length	Code/Data
Request:	Report Level (and Temperature)	4 characters ASCII	Uuu?
Response:	Report Level (and Temperature)	24 characters ASCII	UuuDlll.lFtttEeeeeWwww uu = Address lll.ll = PV in inches ttt = Temperature in Fahrenheit eeee = Error number (0 no error, 1 level data not readable) www = Warning number (0 no warning)

PV in inches will be repeated if "Set number of floats" is set to 2. Hence 2 measured values can be transmitted. PV value is transmitted as first measured value, SV as second

Supplement

measured value.



Information:

The max. value for the PV to be transmitted is 999.99 inches (corresponds to approx. 25.4 m).

If the temperature should be transmitted in the Levelmaster protocol, then TV must be set in the sensor to temperature.

PV, SV and TV can be adjusted via the sensor DTM.

Report Unit Number

	Parameter	Length	Code/Data
Request:	Report Unit Number	5 characters ASCII	U**N?
Response:	Report Level (and Temperature)	6 characters ASCII	UuuNnn

Assign Unit Number

	Parameter	Length	Code/Data
Request:	Assign Unit Number	6 characters ASCII	UuuNnn
Response:	Assign Unit Number	6 characters ASCII	UuuNOK uu = new Address

Set number of Floats

	Parameter	Length	Code/Data
Request:	Set number of Floats	5 characters ASCII	UuuFn
Response:	Set number of Floats	6 characters ASCII	UuuFOK

If the number is set to 0, no level is returned

Set Baud Rate

	Parameter	Length	Code/Data
Request:	Set Baud Rate	8 (12) characters ASCII	UuuBbbb[b][pds] Bbbb[b] = 1200, 9600 (default) pds = parity, data length, stop bit (optional) parity: none = N, even = E (default), odd = O
Response:	Set Baud Rate	11 characters ASCII	

Example: U01B9600E71

Change instrument on address 1 to baudrate 9600, parity even, 7 data bits, 1 stop bit

Supplement

Set Receive to Transmit Delay

	Parameter	Length	Code/Data
Request:	Set Receive to Transmit Delay	7 characters ASCII	UuuRmmm mmm = milliseconds (50 up to 250), default = 127 ms
Response:	Set Receive to Transmit Delay	6 characters ASCII	UuuROK

Report Number of Floats

	Parameter	Length	Code/Data
Request:	Report Number of Floats	4 characters ASCII	UuuF
Response:	Report Number of Floats	5 characters ASCII	UuuFn n = number of measurement values (0, 1 or 2)

Report Receive to Transmit Delay

	Parameter	Length	Code/Data
Request:	Report Receive to Transmit Delay	4 characters ASCII	UuuR
Response:	Report Receive to Transmit Delay	7 characters ASCII	UuuRmmm mmm = milliseconds (50 up to 250), default = 127 ms

Error codes

Error Code	Name
EE-Error	Error While Storing Data in EEPROM
FR-Error	Error in Frame (too short, too long, wrong data)
LV-Error	Value out of limits

Configuration of typical Modbus hosts

The basic number of the input registers is always added to the input register address of NivoGuide 8200.

Supplement

Parameter	Value Fisher ROC 809	Value ABB Total Flow	Value Fisher Thermo Electron Autopilot	Value Fisher Bristol ControlWave Micro	Value Scada-Pack
Baud Rate	9600	9600	9600	9600	9600
Floating Point Format Code	0	0	0	2 (FC4)	0
RTU Data Type	Conversion Code 66	16 Bit Modicon	IEE Fit 2R	32-bit registers as 2 16-bit registers	Floating Point
Input Register Base Number	0	1	0	1	30001

This results in the following constellations:

- Fisher ROC 809 - Register address for 1300 is address 1300
- ABB Total Flow - Register address for 1302 is address 1303
- Thermo Electron Autopilot - Register address for 1300 is address 1300
- Bristol ControlWave Micro - Register address for 1302 is address 1303
- ScadaPack - Register address for 1302 is address 31303

Supplement

Trademark

All the brands as well as trade and company names used are property of their lawful proprietor/originator.

INDEX

A

- Accessories
 - Display and adjustment module 9
- Adjustment
 - Max. adjustment 51, 52
 - Min. adjustment 52, 53
- Adjustment system 45
- Application 50, 51
- Application area 5

B

- Backlight 58
- Baudrate 65

C

- Channel 56
- Connecting
 - Electrically 38
- Connection
 - Steps 38
 - Technology 38
- Copy sensor settings 64
- Curve display
 - Echo curve 59

D

- Damping 54
- Data bits 66
- Date of manufacture 68
- Date/Time 61
- Default values 61
- Deviation 75
- Device status 58
- Display format 57
- Documentation 5

E

- Echo curve memory 71
- Echo curve of the setup 60
- Error codes 74

F

- Factory calibration date 68
- False signal suppression 53
- Fault
 - Rectification 75
- Fault rectification 75
- Floating point format 67
- Format measured value 1 67
- Format measured value 2 67

- Functional principle 5

G

- Gas phase 51

H

- Hardware addressing 41, 48

I

- Inflowing medium 29
- Installation position 26
- Instrument address 41, 48
- Interface 65

K

- Key function 45

L

- Language 57
- Levelmaster 67
- Linearisation 54
- Lock adjustment 56

M

- Main menu 47
- Measured value indication 57
- Measured value memory 70
- Measurement loop name 49
- Measurement reliability 58
- Modbus 56, 66

N

- NAMUR NE 107 71
 - Failure 72
 - Maintenance 74
 - Out of specification 74
- Number of measured values 67

P

- Parity 66
- Peak indicator 58, 59
- Probe length 49
- Probe type 65

Q

- QR code 5
- Quick setup 47

R

- Read out info 68

Repair 80
Reset 61
Response delay 66, 67

S

Scaling measured value 64, 65
Sensor characteristics 68
Serial number 5
Simulation 60
Software addressing 42, 49
Special parameters 68
Stop bits 66

T

Timeout 66
Type label 5
Type of medium 50

U

Units 49

V

Vessel insulation 34

Printing date:

All statements concerning scope of delivery, application, practical use and operating conditions of the sensors and processing systems correspond to the information available at the time of printing.
Subject to change without prior notice

Technical support

Please contact your local sales partner (address at www.uwtgroup.com).
Otherwise please contact us:

UWT GmbH
Westendstraße 5
87488 Betzigau
Germany

Phone + 49 (0) 831 57 123 0
info@uwtgroup.com
www.uwtgroup.com